

Arit

www.ar-it.it

A ARREDAMENTI
ITALIA
IL CUORE DEL LEGNO



Home Harmonies

L'azienda • The Factory • der Betrieb • L'entreprise



• Qualità

Quality
Qualität
Qualite

• Passione artigianale

Handicraft Passion
Leidenschaftliche Handwerk
Passion artisanale

• Cura dei particolari

Care of the details
Besondere Sorgfalt
Soin des details

• Scelta dei materiali

Choice of materials
Leidenschaftliches handwerk
Choix des materiaux

• Produzione quotidiana

Daily production
Fortlaufende produktion
Production quotidienne

• Servizio e collaborazione costante

Constant service and cooperation
Standiger service und zusammenarbeit
Service et collaboration constante

Organico aziendale fine anni '50



Company staff end of '50 Unternehmenpersonal Ende Jahre 50 Personnel dans la fin des années '50

Le origini di **Arredamenti Italia** trovano collocazione nella laboriosa Valle Sabbia, terra di lavoratori in provincia di Brescia. Da qui il signor Eugenio Caccagni intende sviluppare il suo spirito imprenditoriale lavorando il legno, dapprima come terzi per una grande azienda locale, sviluppandosi poi negli anni e proponendo i propri prodotti sul mercato con il marchio **Arredamenti Italia**.

L'azienda fin dalla sua nascita ha saputo far tesoro della tradizione artigianale con le sue regole tramandate ora alla terza generazione.

La produzione **Arredamenti Italia** è frutto di accurato lavoro e costante impegno di un compatto gruppo aziendale che, pur mantenendosi legato alle consuetudini artigiane, affianca le più sofisticate tecnologie della lavorazione del legno con aggiornati investimenti mirando al raggiungimento dei più alti standard qualitativi.

I prodotti **Arredamenti Italia** sono totalmente ed esclusivamente creati nella sede dell'azienda: Bione, Brescia. Il profondo amore nutrito per il legno impone di rispettare l'ambiente; le varie tipologie di legni utilizzati nella realizzazione dei prodotti provengono da zone coltivate con il continuo rimboscamento degli alberi tagliati per mantenere secondo natura l'ambiente.

La collezione **Arredamenti Italia** è realizzata con materiali di alta qualità e processi di produzione accurati, la cura dei particolari e l'alta qualità delle lavorazioni sono ben visibili nella precisione delle finiture.

Le tecnologie ed i materiali innovativi combinano benefici funzionali con durata nel tempo e facilità di manutenzione; la fase finale della produzione testa i prodotti nelle condizioni più critiche prima di essere inoltrati sul mercato.

Arredamenti Italia con gestione ed efficace disponibilità di magazzino riesce a soddisfare le richieste del mercato in tempi molto brevi.

Per arredare i Vostri spazi **Arredamenti Italia** offre linee sobrie ed eleganti unite da comfort e stile.

Staff direttivo attuale

Current Staff

Gegenwärtiges Unternehmenpersonal

Equipe de direction actuel



The origin of **Arredamenti Italia** are to be found in the hard-working Valle Sabbia, a land of workers in the province of Brescia. Starting from here Mr. Eugenio Caccagni plans to develop his entrepreneurial spirit through the carving of wood, first as a local outside contractor, and spreading then throughout the years and proposing his own products on the market with the brand **Arredamenti Italia**.

Since its own birth, the company has been able to treasure the handicraft tradition following its own rules that are now handed down to the third generation. The production of **Arredamenti Italia** is the fruit of an accurate work and a constant engagement of a very compact staff which, yet keeping itself tied to the handicraft habits, joins the most sophisticated technologies with the carving of wood, following updated investments with the aim to achieve the highest qualitative standards.

The products **Arredamenti Italia** are totally and exclusively created at the workshops of the Company Bione Brescia Italy. The deep love nourished for wood calls us to respect the environment; the several types of wood used to realise the products come from areas cultivated with the continuous reforestation of trees, cut to keep the environment fit with nature.

The **Arredamenti Italia** collection is made with high quality materials and accurate production processes, the care of the details and the high quality of the working can well be seen in the accuracies of the finishing touches.

The innovative technologies and materials do combine functional benefits lasting in time and easy to maintain; in the final phase the products are tested in the most critical conditions before being put on the market. With a good management and efficacious stock availability the Company is able to fulfil the market requirements in very short times. To fit out your spaces **Arredamenti Italia** offers sober and elegant lines combined with comfort and style.



Seinen Ursprung findet **Arredamenti Italia** in Valle Sabbia, einem Ort arbeitsamer Menschen in der Provinz Brescia.

Von hier aus möchte Herr Eugenio Caccagni seinen Unternehmergeist durch Holzbearbeitung entwickeln. Anfänglich arbeitete er für eine große Firma; im Laufe der Jahre entwickelte er seine eigenen Produkte, die mit der Marke **Arredamenti Italia** vermarktet wurden. Das Unternehmen machte sich von Anfang an die handwerkliche Tradition zu Nutzen und hat ihre Regeln nun an die dritte Generation weitergeleitet.

Die **Arredamenti Italia** Produktion ist Frucht sorgfältiger Arbeit und stetem Einsatz eines kompakten Betriebs, der den handwerklichen Gepflogenheiten treu bleibt und sich gleichzeitig auf hochentwickelte Technologien der Holzbearbeitung durch Investitionen zum Erreichen immer höherer Qualitätsstandarten stützt.

Die Produkte **Arredamenti Italia** werden vollständig und exklusiv im Betrieb hergestellt: Bione, Brescia. Die Leidenschaft für Holz swingt zum Respekt der Umwelt: die verschiedenen, zur Realisierung der Produkte verwendeten Holzarten stammen aus waldgebenen, die stetig neu bepflanzt werden. Die Kollektion **Arredamenti Italia** besteht aus Qualitätsmaterial und sorgfältigen Produktionsprozessen. Sorgfalt und Qualität der Bearbeitung ragen in der Präzision der Fertigung hervor.

Technologie und innovative Materialien vereinen Funktionalität mit langer Lebensdauer und leichter Wartung. In der Endphase werden die Produkte von innen vermarktet auf das kritischste hin überprüft.

Durch Lagerführung und Bestand können wir der Marktanfrage in kürzester Zeit gerecht werden.

Zur Einrichtung Ihrer Räume bietet **Arredamenti Italia** schlichte und elegante Produkte mit Komfort und Stil an.



Les origines de **Arredamenti Italia** ont pris naissance dans la laborieuse Valle Sabbia, terre de travailleurs dans la province de Brescia.

D'ici Monsieur Eugenio Caccagni a eu l'intention de développer son esprit d'entrepreneur en travaillant le bois, d'abord en qualité de tiers pour une grande compagnie locale, et ensuite en se développant au cours des années et en proposant ses produits sur le marché avec la marque **Arredamenti Italia**. Dès sa naissance la société a été à même de mettre à profit la tradition artisanale avec ses règles, qui sont aujourd'hui transmises à la troisième génération.

La production **Arredamenti Italia** est le résultat d'un travail soigné et d'un engagement d'un groupe d'entreprise compact qui, même en se maintenant lié aux traditions artisanales, va adjoindre les technologies les plus sophistiquées de travail du bois, avec investissements courants, au but d'atteindre les plus hauts niveaux de qualité.

Les produits **Arredamenti Italia** sont totalement et exclusivement réalisés dans la siège de la société: Bione, Brescia.

L'amour profond qu'on nourrit pour le bois impose de respecter le milieu; les divers types de bois utilisés pour la réalisation des produits viennent de zones cultivées avec le reboisement continu des arbres coupés pour garder le milieu selon nature.

La collection **Arredamenti Italia** est réalisée avec matériaux d'haute qualité et procédés de production soignés: le soin des détails et l'haute qualité des travaux sont bien visibles dans la précision des finissages.

Les technologies et les matériaux innovateurs portent à des bénéfices fonctionnels de durée dans le temps et facilité d'entretien; dans la phase finale de la production, avant d'être lancés sur le marché, les produits sont essayés dans les conditions les plus critiques.

Avec une gestion et une efficace disponibilité du magasin on est à même de satisfaire les demandes du marché dans les plus brefs délais.

Pour meubler vos espaces **Arredamenti Italia** offre des lignes sobres et élégantes unies par confort et style.

CUCINA

KITCHEN - KÜCHEN - CUISINE



AREA ATTREZZATA

- Struttura in faggio massiccio
- Ampio piano di lavoro in listellare di faggio
- Due piani d'appoggio laterali apribili in listellare di faggio
- Cestelli in metallo verniciato a polveri
- Due capienti cassetti
- Portabottiglie orizzontale
- Ruote piroettanti e bloccanti in gomma antitraccia

EQUIPED AREA

- Massive beech structure
- Wide working plane in beech lamellate
- 2 opening lateral planes in beech lamellate
- Dust-painted metal rack
- 2 wide massive drawers
- Horizontal little cellar
- Revolving and lamping wheels made of anti-trace rubber

AUSSTATTUNGSFLÄCHE

- Massivbuchenholz Struktur
- große Arbeitsflächen in Buchenholzleiste
- 2 seitliche Ablageflächen in Buchenholzleiste ausziehbar
- Gleitrommel in Pulverbeschichtungsmetall
- 2 geräumige Schubladen
- horizontales Flaschengestell
- Dreh- und Sperräder in gummi no-marking

Santiago cod. 582

DESSERTS CUISINE MULTI-EQUIPEE

- structure en hêtre massif
- plan de travail avec égouttoir équipé de deux plateaux latéraux rabattables
- paniers en métal vernis à la poudre
- 2 tiroirs
- range bouteilles horizontal
- roulettes pivotantes antitraces dont 2 avec frein

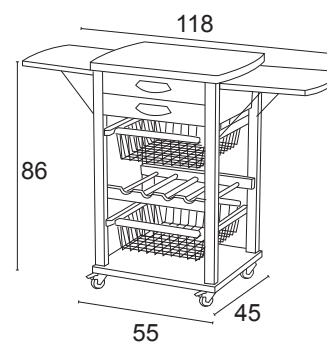



AREA CUCINA

- Struttura in faggio massiccio
- Tagliere apribile in listellare di faggio
- Cestelli in metallo verniciato a polveri
- Ampio cassetto massiccio
- Ruote piroettanti e bloccanti in gomma antitraccia

Gastone cod. 585



KITCHEN AREA

- Massive beech structure
- Openable chopping board in beech lamellate
- Dust-painted metal rack
- Wide massive drawer
- Revolving and lamping wheels made of anti-trace rubber

KÜCHENRAUM

- Massivbuchenholz Struktur
- Aushlappbars Schneidebrett in Buchenholzeiste
- Pulverbeschichtetem Metal Körbe
- Geräumige Holz Massivschublade
- Dreh-und Sperrräder in Zeichensicher-Gummi

DESSERTERIE CUISINE

- structure en hêtre massif
- planche à découper en hêtre lamellé avec égouttoir
- paniers en métal vernis à la poudre
- ample tiroir en bois massif
- range bouteilles horizontal et vertical
- range couteaux
- roulettes pivotantes antitraces dont 2 avec freins



naturale - natural - natürlich - naturelle

wenghé - wenghé - wengé



ciliegio - cherry wood - Kirschholz - merisier



laccato bianco - white lacquered
weisslackiert - laqué blanc

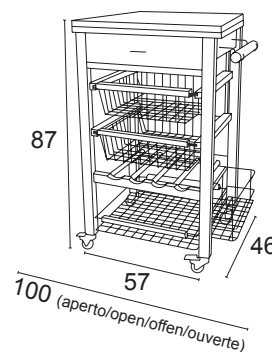

CARRELLO CUCINA

- Struttura in faggio massiccio
- Tagliere apribile in listellare di faggio
- Cestelli scorrevoli in metallo verniciato a polveri
- Ruote piroettanti antitraccia

Gastoncino

cod. 518

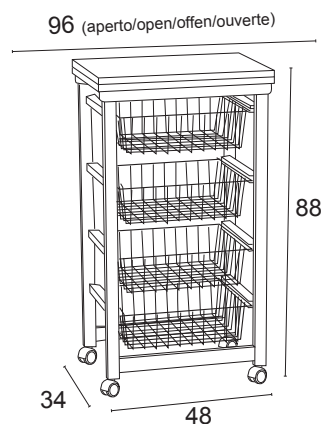

KITCHEN TROLLEY

- Structure in solid beech
- Openable chopping board in multi-layer beech wood
- Metal sliding baskets, powder-coated
- Swiveling wheels

KÜCHENWAGEN

- Struktur aus massivem Buchenholz
- Aufklappbares Hackbrett aus Buchenholz
- Metall-Schiebekörbe pulverbeschichtet
- Schwenkräder

DESSERTS CUISINE

- Structure en hêtre massif
- Plaque à hacher ouvrable en hêtre plaqué
- Paniers métalliques coulissants vernis au poudre
- Roues pivotantes



laccato bianco - white lacquered
weisslackiert - laqué blanc

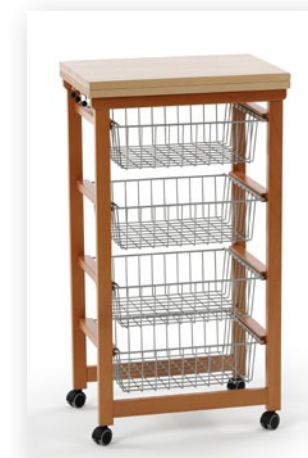

ciliegio - cherry wood
Kirschholz - merisier



PORTA VERDURA

Ginger cod. 500

VEGETABLES BASKETS

GEMÜSEKORB

DESSERTS A LEGUMES

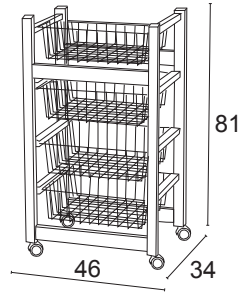

PORTA VERDURA CON PIANO

- Struttura in faggio massiccio
- Ripiano in truciolare nobilitato
- Cestelli scorrevoli in metallo verniciato a polveri
- Ruote piroettanti in gomma antitraccia

GingerOne cod. 515

VEGETABLES BASKETS WITH PLAN

- Massive beech structure
- Noble chipboard shelves
- Dust-painted metal rack
- Revolving wheels made of anti-trace rubber

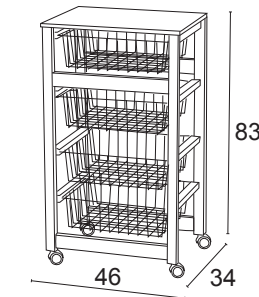

GEMÜSEKORB MIT PLAN

- Massivbuchenholz Struktur
- Ebene in veredelte Kernholz Spanplatte
- Trommel in Pulverbeschichtungsmetall
- Dreh- und Sperrräder in Zeichensicher-Gummi

DESSERTS A LEGUMES AVEC PLAN

- structure en hêtre massif
- plateau en panneaux de particules
- paniers en métal vernis à la poudre
- roulettes pivotantes antitraces



Ginger + Drink

VASSOIO

Drink cod. 510

TRAY

TABLETT

PLATEAU PETIT DEJEUNER



laccato bianco - white laquered
weiß lack - laqué blanc



ciliegio - cherry wood
Kirschholz - merisier



CEPPO CANTINA

- Struttura in faggio massiccio
- Tagliere in listellare di faggio
- Cestelli in metallo verniciato a polveri
- Ampio cassetto massiccio
- Ruote piroettanti in gomma antitraccia

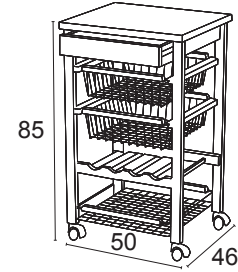

Arturo cod. 540

CHOPPING BLOCK, CELLAR

- Massive beech structure
- Chopping board in beech lamellate
- Dust-painted metal rack
- Wide massive drawer
- Revolving wheels made of anti-trace rubber

KELLER SCHNEIDEBRETT

- Massivbuchenholz Struktur
- Schneidebrett in Buchenholzleiste
- Pulverbeschichtetem Metal Körbe
- Geräumige Massivschublade
- Dreh-und Sperrräder in Zeichensicher-Gummi

DESSERTTE MULTI FONCTIONS

- structure en hêtre massif
- Planche à découper en hêtre lamellé
- tiroir en bois massif
- paniers en métal vernis à la poudre
- range bouteilles
- roulettes pivotantes antitracesi



Arturo cod. 546

CEPPO CANTINA

- CHOPPING BLOCK, CELLAR
- KELLER SCHNEIDEBRETT
- DESSERTTE MULTI FONCTIONS



wenghé - wenghé - wengé



sbiancato - whitened
gebleicht - blanchie



CARRELLO CUCINA

- Struttura in faggio massiccio
- Tagliere in listellare di faggio
- Cestelli in metallo verniciato a polveri
- Ampio cassetto massiccio
- Ruote piroettanti in gomma antitraccia

Raikon

cod. 530

KITCHEN TROLLEY

- Massive beech structure
- Chopping board in beech lamellate
- Dust-painted metal rack
- Wide massive drawer
- Revolving wheels made of anti-trace rubber

KÜCHENWAGEN

- Massivbuchenholz Struktur
- Schneidebrett in Buchenholzleiste
- Pulverbeschichtetem Metal Körbe
- Geräumige Massivschublade
- Dreh-und Sperrräder in Zeichensicher-Gummi

DESSERTS CUISINE

- structure en hêtre massif
- Planche à découper en hêtre lamellé
- tiroir en bois massif
- paniers en métal vernis à la poudre
- range bouteilles
- roulettes pivotantes antitraces

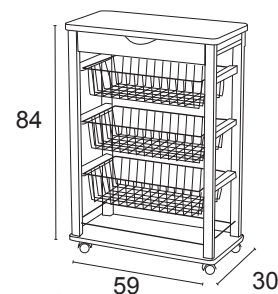

PORTAVERDURA

Oliver cod. 594

VEGETABLES BASKET
GEMÜSEKORB
DESSERTS MULTI FONCTIONS

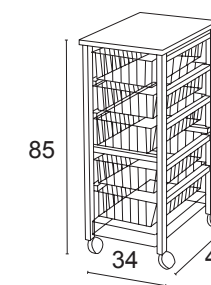

RACCOGLITORE DI DIFFERENZIATA

- Struttura in truciolare nobilitato
- Cornici in legno massiccio
- Singola apertura delle antine
- Ruote piroettanti antitraccia alla base
- Contenitori orientabili in materiale plastico da 12 litri
- Ideale per piccoli spazi.

Madera 2 cod. 872

DIFFERENTIAL COLLECTOR

- Noble chipboard structure
- Massive wooden frames and upper shelf
- Single opening of doors
- Anti-trace revolving wheels at the base
- 12 litres orientable containers in plastic material
- Ideal for little spaces.



GETRENNTE MÜLLSAMMLUNG

- veredelte Kernholzstruktur
- Massivholz Rahmen
- Einzelöffnung der Türe
- Basis schwenren Drehräder
- 12 Lt. verstellbare Plastikbehälter
- Ideal für kleine Räume

POUBELLE TRI SELECTIF

- structure en panneaux de particules
- cadre en bois massif
- ouverture individuelle des placards
- roulettes pivotantes antitraces
- 2 poubelles en plastiques
- idéal pour les petites espaces



ciliegio - cherry wood - Kirschholz - merisier



laccato bianco - white lacquered - weisslackiert - laqué blanc



RACCOGLITORE DI DIFFERENZIATA

- Ideale per raccolta carta - vetro - alluminio - plastica

Madera 4 cod. 874

DIFFERENTIAL COLLECTOR

- Ideal for collection paper - glass - aluminium - plastic

GETRENNTE MÜLLSAMMLUNG

- Ideal zum sammeln von Papier - Glass - Aluminium - Plastik

POUBELLE TRI SELECTIF

- Idéal pour la collecte Papier - verre - aluminium - plastique

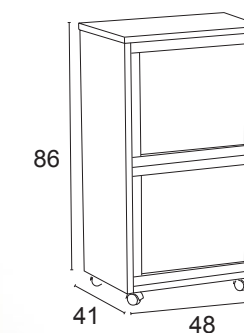

laccato bianco
white lacquered
weisslackiert
laqué blanc



ciliegio
cherry wood
Kirschholz
merisier



CARRELLO CANTINA

- Struttura in faggio massiccio
- Ripiano truciolare nobilitato
- Aste in alluminio
- Ruote piroettanti in gomma antitraccia

Kristall cod. 544

TROLLEY CELLAR

- Massive wooden structure
- Noble chipboard shelves
- Aluminium rods
- Anti-trace revolving wheels

KELLERTABLETT

- Massivbuchenholz Struktur
- Ebene in veredelte Kernholz Spanplatte
- Aluminiumstangen
- Dreh- und Sperräder in Zeichensicher-Gummi

CHARIOT À BOUTEILLES

- structure en hêtre massif
- plateau en panneaux de particules
- tiges en aluminium
- roulettes pivotantes antitraces



CANTINETTA

- Completamente in faggio massiccio
- Piedini in gomma alla base

Ardesia cod. 545

LITTLE CELLAR

- Whole massive wood
- Rubber feet at the base

WEINKELLER

- Vollständiges Massivbuchenholz
- Gummi-Füßchen an dr basis

CASIER DE RANGEMENT POUR BOUTEILLES

- Entièrement en hêtre massif
- 6 casiers de rangement
- Capacité 30 bouteilles
- Patins en caoutchouc à la base des pieds

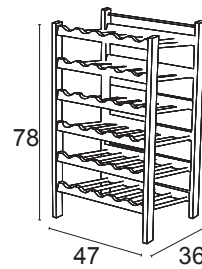

Birellone

CANTINETTE MODULARI

- Completamente in faggio massiccio
- Semplice sistema di assemblaggio
- Piedini alla base per appoggio e sistema modulare
- Disponibili in versione ciliegio

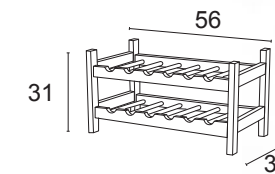

cod. 547
12 POSTI
PLACES - ORTE - LIEUX

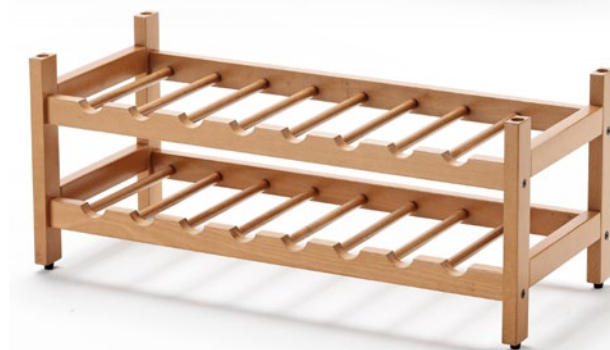
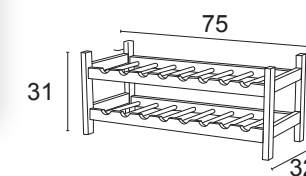

cod. 549
16 POSTI
PLACES - ORTE - LIEUX

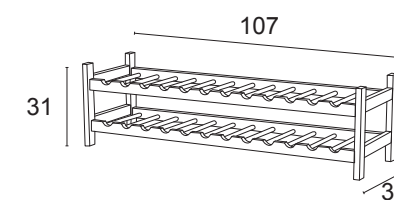

cod. 550
24 POSTI
PLACES - ORTE - LIEUX

STIRO

IRON - BÜGELN - REPASSER



TAVOLO DA STIRO REGOLABILE

- Struttura in faggio massiccio
- Regolabile in 4 altezze
- Piano in rete traforato e zincato
- Ampia griglia portacaldaia a scomparsa
- Ruote alla base che "lavorano" in posizione chiusa
- Capiente piano portaindumenti
- Fodera esclusiva in puro cotone

EINSTELLBARES BÜGELBRETT

- Massivbuchenholz Struktur
- Einstellbar auf 4 Höhen
- Durchbrochene und verzinkte Netzebene
- Grosses einziehbares Bügelträgergitter
- Räder an der Basis, die in Schließstellung
- Grosse Kleiderfläche
- Exklusiver Baumwollberzuy

ADJUSTABLE IRONING BOARD

- Massive beech structure
- Adjustable in 4 heights
- Board in fret-worked and galvanised net
- Wide foldway grid for steam iron support
- Wheel on the base acting in closed position
- Capacious garment holder
- Exclusive pure cotton cover

Stirocomodo cod. 621

PLANCHE A REPASSER REGLABLE

- structure en hêtre massif
- plateau en métal ajouré
- Dimensions plateau : 108X45 , réglable en 4 hauteurs
- grille repose fer ou centrale vapeur
- roulettes pivotantes pour faciliter le déplacement en position fermée
- plateau supplémentaire pour repose linge
- housse en 100% coton
- disponible en finition naturelle ou merisier, blanchis ou wengé



TAVOLO DA STIRO REGOLABILE

Stirocomodo cod. 621

ADJUSTABLE IRONING BOARD

EINSTELBARES BÜGEL BRETT

PLANCHE A REPASSER REGLABLE



ciliegio - cherry wood
Kirschholz - merisier



wenghé - wenghé - wengé



naturale - natural
natürlich - naturelle

laccato bianco
white lacquered
weisslackiert
laqué blanc



altezza regolabile in 4 posizioni
4 - positions adjustable height
Einstellbar auf 4 Höhen
Hauteur réglable en 4 positions

93
91
88
84

TAVOLO DA STIRO

- Piano in rete traforato e zincato
- Capiente piano portaindumenti
- Ampia griglia portacaldaia a scomparsa

IRONING BOARD

- Board in fret-worked and galvanised net
- Capacious garment holder
- Wide foldway grid for steam iron support

BÜGELBRETT

- Durchbrochene und verzinkte Netzebene
- Grosse Kleiderfläche
- Grosses einziehbares Bügelträgergitter

PLANCHE À REPASSER

- Surface en réseau percé et zingué
- Grand rayon porte-vêtements
- Grande grille porte-chaudière à disparition

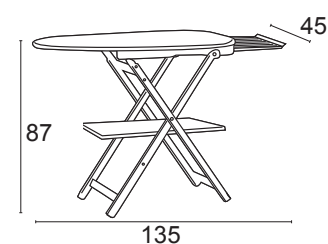

Astir cod. 622



Ministyro

cod. 637

MINI STIRO PORTATILE E REGOLABILE

- Struttura in faggio massiccio
- Regolabile in 4 altezze
- Piano in rete traforato e zincato
- Fodera esclusiva in puro cotone
- Piedini in gomma antiscivolo
- Facilmente richiudibile

MINI BÜGELBRETT – TRAGBAR UND VERSTELLBAR

- Struktur aus massivem Buchenholz
- Einstellbar auf 4 Höhen
- Ebene aus durchbrochenem und verzinktem Netz
- Exklusiver Baumwollüberzug
- Rutschfeste Gummifüße
- Leicht faltbar

MINI PLANCHE A REPASSER PORTABLE ER REGLABLE

- Structure en hêtre massif
- Réglable à 4 hauteurs
- Réseau en plan perforé et galvanisé
- Doublure exclusive en coton pur
- Pieds antidérapants en caoutchouc
- Facilement pliable

LITTLE PORTABLE ADJUSTABLE IRONING BOARD

- Massive wooden structure
- Adjustable in 4 heights
- Board in fret-worked and galvanised net
- Exclusive pure cotton cover
- Non slip rubber feet
- Easy to close

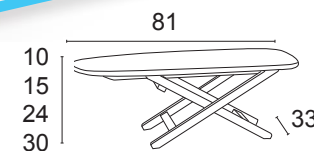

naturale - natural
natürlich - naturelle



ciliegio - cherry wood
Kirschholz - merisier

TAVOLO DA STIRO REGOLABILE

- Piano multistrato di pino fenolico
- Struttura in faggio massiccio
- Il piano più grande della sua categoria 115x54
- Sistema di regolazione del piano unico nel suo genere
- Ripiani apribili con sistema "aprifacile"
- Ampia griglia portacaldaia
- Ruote piroettanti che "lavorano" in posizione chiusa
- Chiuso sta in piedi da solo

Bravo cod. 620

ADJUSTABLE IRONING BOARD

- Multilayer plane in phenolic pine wood
- Massive beech structure
- The widest board in its category
- Unique board adjusting system
- Shelves can be opened with "easy to open" system
- Wide boiler holding grid
- Revolving wheels acting in closed position
- When closed it stands alone

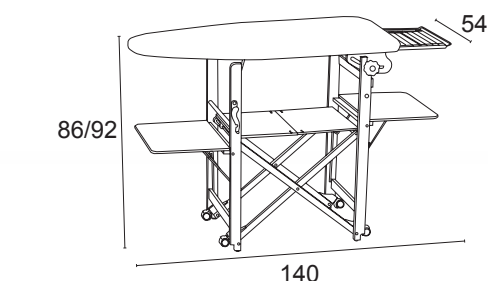

EINSTELLBARES BÜGELBRETT

- Mehrschichtige Fläche in Phenol-Kieferholz
- Massivbuchenholz Struktur
- Die größte Fläche seiner Kategorie 115x54
- Einstellungssystem der Fläche einzig in seiner Art
- Fachböden mit System
- Grosses Bügelträgergitter
- Räder an der basis, die in SchlieBstellung
- Geschlossen, steht es von selbst

PLANCHE A REPASSER REGLABLE

- structure en hêtre massif
- plateau en contreplaqué
- Dimensions plateau : 115X54 , réglable en plusieurs hauteurs
- grille repose fer ou centrale vapeur
- roulettes pivotantes pour faciliter le déplacement en position fermée
- plateau supplémentaire pour repose linge
- housse en 100% coton



sistema di regolazioni in più altezze
adjusting system for several heights
Einzigartiges flächeneinstell-system
Système de réglage à plusieurs hauteurs



MOBILE DA STIRO

- Particolari in faggio massiccio
- Struttura in truciolare nobilitato
- Piano in rete traforato e zincato
- Ruote piroettanti
- Piedino regolabile per stabilità

BÜGELBRETT

- Massivbuchenholz Bestandteile
- Struktur in veredelte Spanplatte
- Durchbrochene und verzinkte Netzebene
- Drehräder
- Einstellbares Füßchen für Standfestigkeit

MEUBLE POUR REPASSAGE

- structure en hêtre massif et panneaux de particules mélaminés
- plateau en métal ajouré, dimensions cm 107x45
- roulettes pivotantes
- pied réglable pour meilleure stabilité

Stiromobile

cod. 630

IRONING FURNITURE

- Massive wood details
- Noble chipboard structure
- Fret-worked and galvanised net plane
- Revolving wheels
- Adjustable foot



noce - walnut
Nussbaumholz - noix

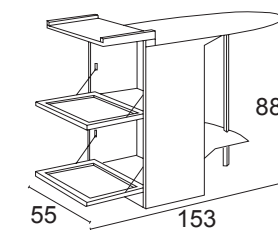
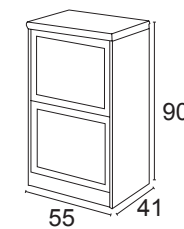

laccato bianco - white laquered
weiß lack - laqué blanc



ciliegio - cherry wood
Kirschholz - merisier

naturale - natural
natürlich - naturelle

MOBILETTO STIRO

- Particolari in faggio massiccio
- Struttura in truciolare nobilitato
- Piano multistrato di pino fenolico
- Ruote piroettanti

IRONING FURNITURE

- Massive wood details
- Noble chipboard structure
- Multilayer plane in phenolic pine wood
- Revolving wheels



doppio piedino regolabile per stabilità nella stiratura
 double feet for mayor stability in ironing
 2 einstellbare Füßchen für Standfestigkeit des Bügelns
 Double petit pied réglable pour la stabilité dans le repassage

Stirallegro cod. 612

BÜGELMÖBELSTÜCK

- Massivbuchenholz Bestandteile
- Struktur in veredelte Spanplatte
- Mehrschichtige Fläche in Phenol-Kieferholz
- Drehräder

MEUBLE POUR REPASSAGE

- structure en hêtre massif et panneaux de particules mélaminés
- plateau en contreplaqué, dimensions 95X38
- roulettes pivotantes
- pieds supplémentaires réglables pour meilleure stabilité

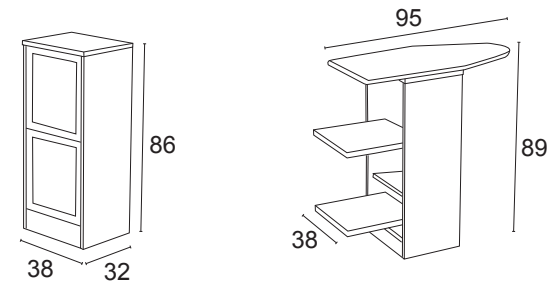

Stirosvelto cod. 635 CHIUDIBILE / CAN BE CLOSED / ZUSAMMENHLAPPBAR / MINITABLE A REPASSER

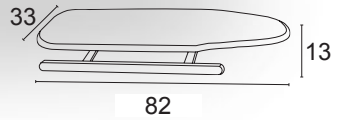

Stiromaniche cod. 625 CHIUDIBILE / CAN BE CLOSED / SCHLISSBAR / VERROUILLABLE

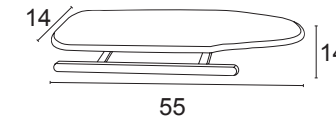

Bird cod. 629 STIROMANICHE FISSO / FIXED SLEEVE BOARD / FESTSTEHENDES / JEANNETTE FIXE

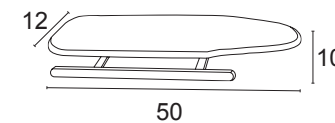

Mollettone

cod. 614 PER/FOR/POUR STIRALLEGRO

cod. 624 PER/FOR/POUR BRAVO

cod. 627 PER/FOR/POUR STIROMOBILE-STIROCOMODO-ASTIR



Fodera

cod. 613 PER/FOR/POUR STIRALLEGRO

cod. 623 PER/FOR/POUR BRAVO

cod. 626 PER/FOR/POUR STIROMOBILE-STIROCOMODO-ASTIR



STENDI

CLOTHESHORSE
WÄSCHESTÄNDER
ETENDOIR



STENDIBIANCHERIA

- Struttura in legno massiccio
- Griglie indipendenti in nylon
- Aste in alluminio verniciato a polveri
- Doppia vaschetta portamollette orientabile
- Ruote piroettanti antitraccia
- 30 mt di filo utile

CLOTHESHORSE

- Massive wooden structure
- Independent nylon grids
- Dust-painted aluminium rods
- Double orientable clothes pegs basket
- Anti-trace revolving wheels
- 30 mt of useful line

Gabbiano
cod. 600

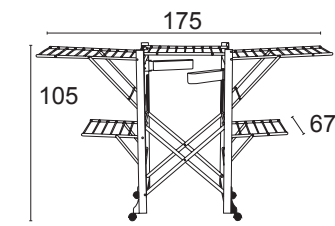

TROCKENGESTELL

- Massivholz Struktur
- Unabhängige Nylon Gitter
- Stangen in Pulverbeschichtungsmetall
- Doppel verstellbare Wäscheklammerschale
- Drehräder in Zeichensicher-Gummi
- 30 mt nutzbarer Draht

SÉCHOIR LINGE À POSER

- Structure hêtre massif
- Grilles en nylon indépendantes
- Tiges en aluminium vernis à la poudre
- Double panier orientable pour pinces à linge
- Roulettes pivotantes antitraces
- 30 m d'étendage





cm 12

Gabbiano

SISTEMA APRIFACILE UNICO NEL SUO GENERE

EASY TO OPEN SYSTEM UNIQUE IN ITS WAY

EINFACH ZU ÖFFNEN SYSTEM EINZIG IN SEINER ART

SYSTÈME FACILE-À-OUVRIR UNIQUE DANS SON GENRE



sbiancato - whitened
gebleicht - blanchie



ciliegio - cherry wood
Kirschholz - merisier



wenghé - wenghé - wengé



laccato bianco - white laquered
weiß lack - laqué blanc

LO STENDILENZUOLA

- Struttura in nylon
- Aste in alluminio verniciato a polveri
- Applicabile a Gabbiano, Airone e Aquilone
- Sviluppo di 6,5 mt di filo utile
- Altezza massima da terra cm 123

THE BLANKETSHORSE

- Nylon structure
- Dust-painted aluminium rods
- Applicable to Gabbiano, Airone and Aquilone
- Development of 6,5 mt of useful line
- Max height from floor cm 123

Pellikano

cod. 601

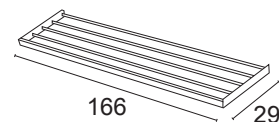

BETTLAKENGESTELL

- Nylon Struktur
- Stangen in Pulverbeschichtungsmetall
- An Gabbiano, Airone und Aquilone anbringbar
- Insgesamt 6,5 Mt nutzbarer Draht
- Max Höhe von Boden cm 123

SECHOIR POUR DRAP

- Structure en nylon
- Tiges en aluminium vernis à la poudre
- Applicable à Gabbiano, Airone et Aquilone
- 6,5 mètres d'étendage
- Hauteur maximum du sol 123 cm

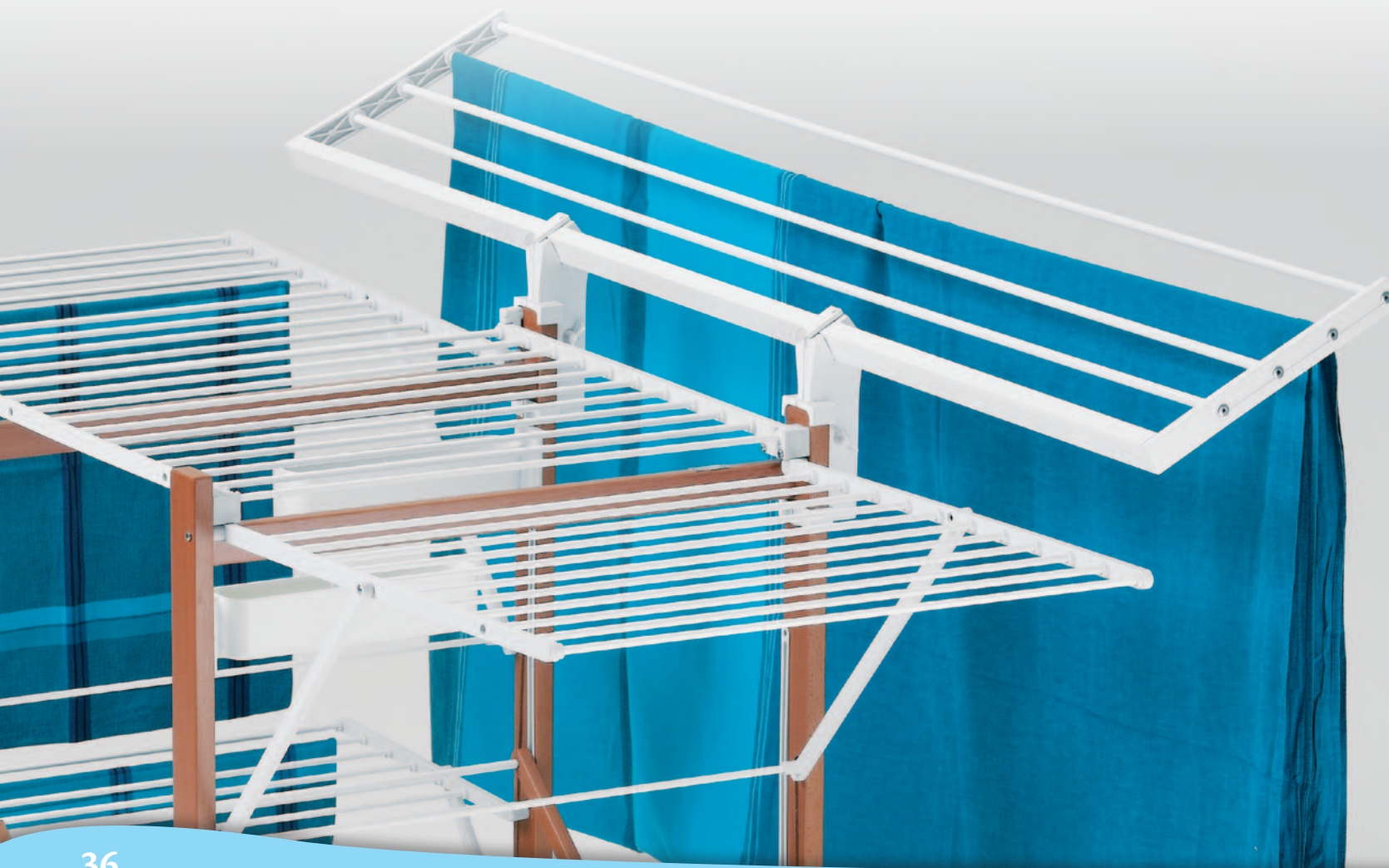
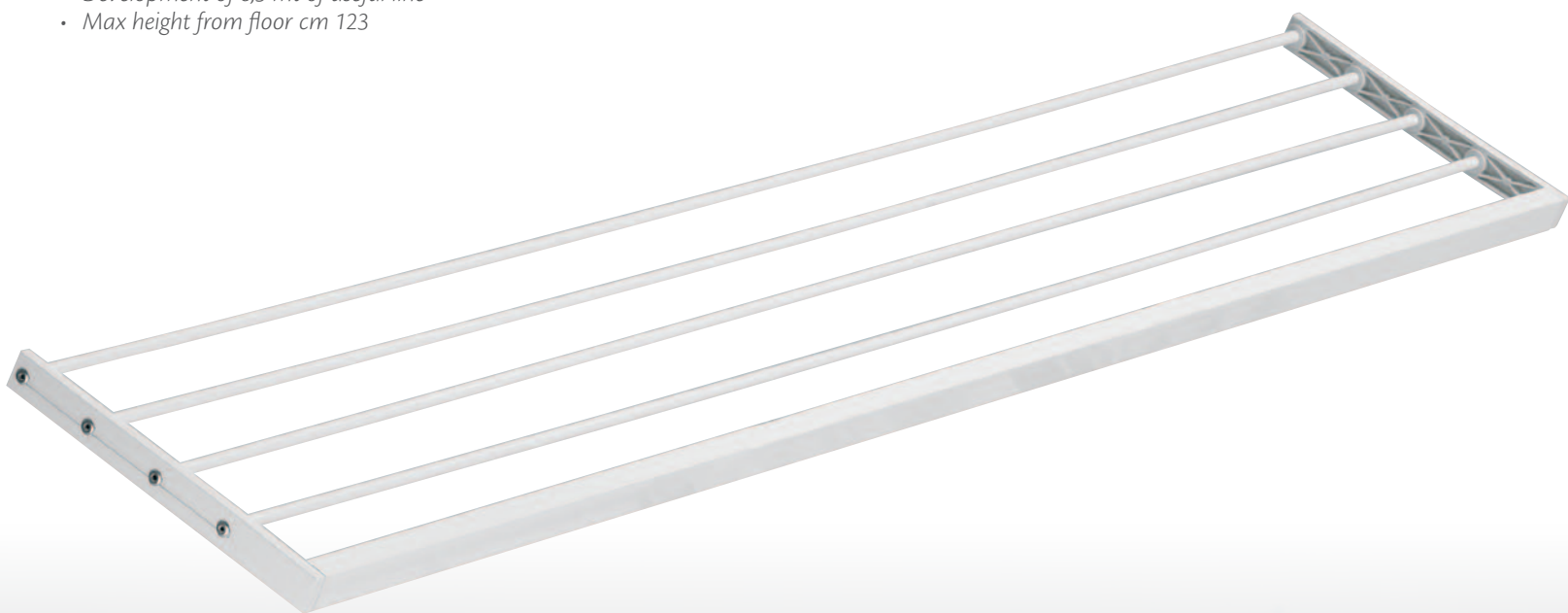

STENDIBIANCHERIA

- Telaio portante in faggio massiccio
- 3 telai in nylon e alluminio verniciato
- 21 metri di filo utile
- Ruote per un facile spostamento
- Vaschetta portamollette orientabile
- Chiuso occupa poco spazio

Airone

cod. 999

**SISTEMA APRIFACILE
UNICO NEL SUO GENERE**
EASY TO OPEN SYSTEM UNIQUE IN ITS WAY
EINFACH ZU ÖFFNEN SYSTEM EINZIG IN SEINER ART
SYSTÈME FACILE-À-OUVRIR UNIQUE DANS SON GENRE

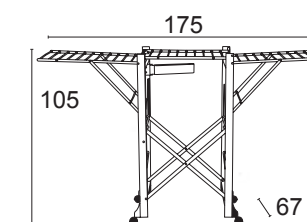
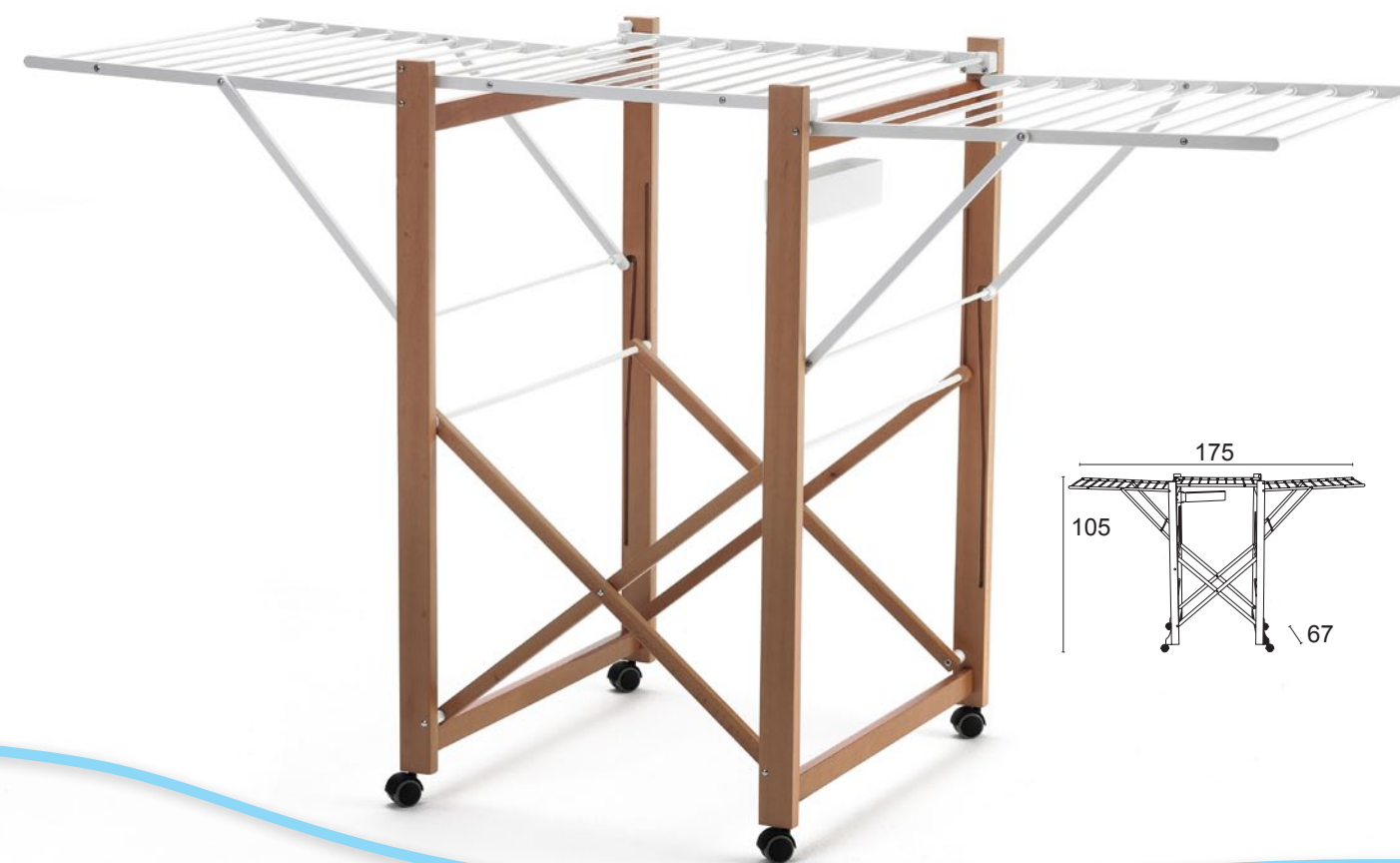

cm 10



semplice da applicare e togliere
easy to apply and remove
einfach anzubringen und zu entfernen
Simple à appliquer et enlever



Gabbiano più 1 Pellikano
Gabbiano with 1 Pellikano
Gabbiano mehr 1 Pellikano
Gabbiano plus 1 Pellikano



Gabbiano più 2 Pellikano
Gabbiano with 2 Pellikano
Gabbiano mehr 2 Pellikano
Gabbiano plus 2 Pellikano

TROCKENGESTELL

- Massivholz Struktur
- 3 Unabhängige Nylon Gitter
- Stangen in Pulverbeschichtungsmetall
- Verstellbare Wäscheklammerschale
- Drehräder in Zeichensicher-Gummi
- 21 mt nutzbarer Draht

SÉCHOIR LINGE À POSER

- Structure hêtre massif
- 3 Grilles en nylon indépendantes
- Tiges en aluminium vernis à la poudre
- Panier orientable pour pinces à linge
- Roulettes pivotantes antitraçes
- 21 m d'étendage

STENDIBIANCHERIA

- Struttura in faggio massiccio
- 7 griglie indipendenti in nylon
- Aste in alluminio verniciato a polveri
- Ruote piroettanti e bloccanti antitraccia
- 40 metri di filo utile

AQUILONE

cod. 602

CLOTHESHORSE

- Structure in solid beech
- 7 independent nylon grids
- Powder-coated aluminum rods
- Swiveling and non-marking self-locking wheels
- 40 mt. of working wire



TROCKENGESTELL

- Struktur aus massivem Buchenholz
- 7 unabhängige Nylonritter
- Stangen in pulverbeschichtetem Aluminium
- Zeichenschutz selbstsperrbare Schwenkräder
- 40 Meter nützliche Draht

SÉCHOIR LINGE À POSER

- Structure en hêtre massif
- 7 grilles nylon indépendantes
- Tiges en d'aluminium vernis au poudre
- Roues pivotantes et autobloquantes anti-trace
- 40 mt. de fil utile



SISTEMA APRIFACILE UNICO NEL SUO GENERE

EASY TO OPEN SYSTEM UNIQUE IN ITS WAY
EINFACH ZU ÖFFNEN SYSTEM EINZIG IN SEINER ART
SYSTÈME FACILE-À-OUVRIR UNIQUE DANS SON GENRE



chiuso cm 12 - closed cm 12
geschlossen cm 12 - clos cm 12



STENDIBIANCHERIA DA TERMOARREDO

- Realizzato in faggio massiccio
- Griglie indipendenti in nylon
- Aste in alluminio verniciate a polvere
- Facilmente richiudibile
- 10 metri di filo utile
- Dotato di sistema di aggancio a scomparsa

Klaus cod. 608

CLOTHESHORSE FOR TERMOARREDO

- Massive wooden structure
- Independents nylon grids
- Dust painted aluminium rods
- Easy to close
- 10 Mt of useful line
- Equipped with attachment a disappearance

TROCKENGESTELL FÜR THERMOAUSSTATTUNG

- Aus massivem Buchenholz
- unabhängige Nylongitter
- Stangen in pulverbeschichtetem Aluminium
- leicht faltbar
- 10 Meter Draht nützlich
- Ausgestattet mit einem einziehbaren Haken

ETENDOIR A LINGE THERMO-AMEUBLEMENT

- Fabriqué en hêtre massif
- Grilles nylon indépendantes
- Tiges en d'aluminium vernis au poudre
- Facilement pliable
- 10 mt. de fil utile
- Equipé d'un crochet rétractable

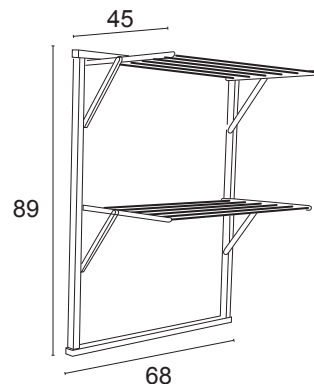

ciliegio - cherry wood
Kirschholz - merisier



laccato bianco - white laquered
weiß lack - laqué blanc



Gancio a scomparsa - attachment a disappearance
einziehbaren Haken - crochet rétractable



LO STENDIPARETE

- Dotato di sistema per fissaggio a parete
- Comodo per piccoli spazi
- 6,5 mt filo utile

Kledy cod. 604

WALL-CLOTHESHORSE

- Provided with a suitable system for wall fixing
- Convenient for little rooms
- 6,5 mt of useful line

WAND- WÄSCHESTÄNDER

- Ausgestattet mit Wandfixierungssystem
- Praktisch für kleine Räume
- 6,5 Mt nutzbarer Draht

ETENDOIR A LINGE MURAL

- Prévu pour les petits espaces
- 6,5 mètres de fil d'étendage

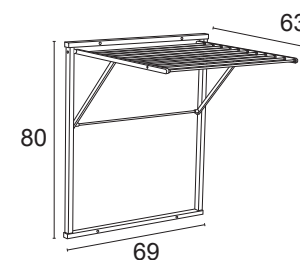

ciliegio - cherry wood
Kirschholz - merisier



laccato bianco - white laquered
weiß lack - laqué blanc

STENDIBIANCHERIA A TORRE

Karisma

cod. 695

CLOTHESHORSE TOWER
TROCKENGESTELL TOWER
SÉCHOIR LINGE À POSER TOUR

- 25 mt filo utile
- 25 mt of useful line
- 25 mt nutzbarer Draht
- 25 mètres de fil d'étendage

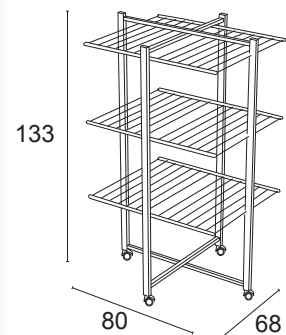

chiuso cm 9
closed cm 9
zusammengelaopt cm 9
clos cm 9



Banny

 cod. 605

PORTABIANCHERIA
BLANKETSHORSE
WÄSCHEKORB
CORBEILLE A LINGE BANNY

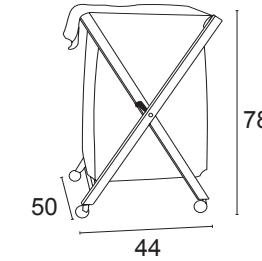

- Struttura in faggio massiccio
- Ruote antitraccia piroettanti
- Sacca in cotone ecrù estraibile
- Facilmente richiudibile

- Structure in massive wood
- Anti-trace revolving wheels
- Removable cotton off-white bag
- Easy-to-close

- Massivbuchenholz Struktur
- Drehräder in Zeichensicher-Gummi
- Ausziehbarer Baumwolle beige Sack
- Einfach zu schließen

- Structure en hêtre massif
- Roulettes pivotantes antitraces
- sac en coton écreu détachable
- Ouverture et fermeture facile

Minù

 cod. 607

ACCESSORIO BAGNO
BATHROOM ACCESSORIES
BADEZIMMER ACCESSORIE/ZUBEHTT
ACCESSOIRE SALLE DA BAIN

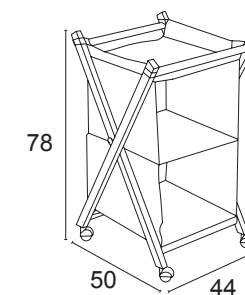

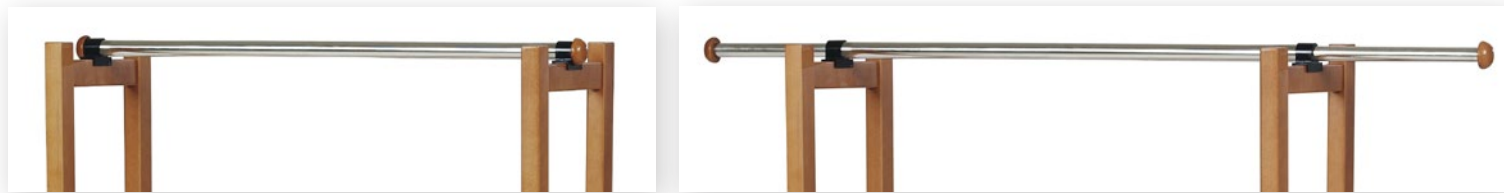

IL METTINORDINE

- Realizzato in faggio massiccio
- Con barre acciaio estensibili sui 2 lati
- Ampio piano appoggio inferiore
- Ruote antitraccia piroettanti
- Facilmente richiudibile

THE TIDY-UP

- Realized in massive wood
- With extendable irons bars on 2 sides
- Wide lower resting plane
- Anti-trace revolving wheels
- Easy-to-close

RÄUMT-AUF

- In Massivbuchenholz realisiert
- Mit Stahlstangen auf 2 Seiten ausziehbar
- Grosse Ablagetlaude
- Drehräder in Zeichensicher-Gummi
- Einfach zu schließen

PORTANT PLIABLE

- Structure en hêtre massif
- barre d'acier chromé extensible des deux côtés
- planche de rangement au niveau inférieur
- roulettes pivotantes antitraces
- ouverture et fermeture facile

APPENDIABITI CHIUDIBILE

- Struttura in faggio massiccio
- Barra in acciaio satinato
- Ruote antitraccia piroettanti alla base
- Facilmente richiudibile
- Disponibile nelle versioni ciliegio e bianco

BLANKETSHORSE

- Realized in massive wood
- With irons bars
- Anti-trace revolving wheels
- Easy to close
- Available in cherry wood and white

PORTEMANTEAU

- Structure en hêtre massif
- Bar en acier brossé
- Roues non marquantes pivotantes
- Facilement pliable
- Disponible en cerisier et blanc

Giulyus cod. 644

KLEIDERSTÄNDER

- Struktur aus massivem Buchenholz
- Bar in gebürstetem Stahl
- Zeichenschutz schwenkbare Räder
- Leicht faltbar
- Erhältlich in Kirschholz und Weiß

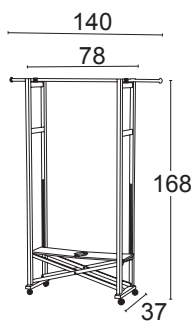
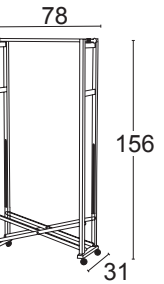

naturale - natural
natürlich - naturelle

Elios
cod. 642

ciliegio - cherry wood
Kirschholz - merisier



laccato bianco - white laquered
weiß lack - laqué blanc

ciliegio - cherry wood
Kirschholz - merisier

SOGGIORNO

LIVING-ROOM
WOHNZIMMER
SALON

MENSOLA PICCOLA

- Struttura in faggio massiccio
- Mensola modulare orientabile
- Facile da appendere al muro
- Ideale per libri e cd
- Completa di supporto per parete
- Semplice da assemblare

Viky cod. 3001

LITTLE SHELF

- Massive wooden structure
- Adjustable modular shelving
- Easy to hang on the wall
- Ideal for books and cd
- Full support for wall,
- Easy to assemble

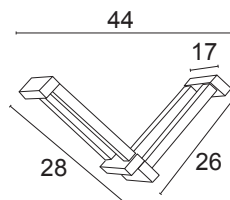

KLEINES REGAL

- Struktur aus massivem Buchenholz
- einstellbares Modulregal
- Einfach an die Wand zu hängen
- Ideal für Bücher und CDs
- Komplet mit Wandhalterung
- Einfach zu montieren

PETIT TABLETTE

- Structure en hêtre massif
- Etagère modulaire réglable
- Facile à accrocher au mur
- Idéal pour des livres et des CD
- Equipée de support mural
- Facile à assembler



naturale - natural
natürlich - naturelle

tabacco - tobacco
Tabak - tabac

sabbia - sand
sand - sable

ciliegio - cherry wood
Kirschholz - merisier

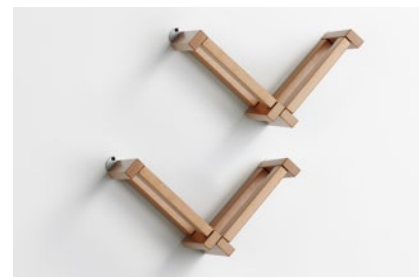

Le immagini propongono composizioni di N. 2 mensole Viky
The images suggest compositions of N. 2 shelves Viky
Die Bilder legen Kompositionen von N. 2 Regale Viky vor
Les images montrent des compositions de N. 2 tablettes Viky

MENSOLA

- Struttura in faggio massiccio
- Aste in metallo satinato
- Mensola modulare orientabile
- Facile da appendere al muro
- Ideale per libri e cd
- Completa di supporto per parete
- Semplice da assemblare

STOOL

- Massive wooden structure
- Auccions metal satin
- Adjustable modular shelving
- Easy to hang on the wall
- Ideal for books and cd
- Full support for wall, easy to assemble

PLATEAU

- Structure en hêtre massif
- Tiges en métal brossé
- Etagère modulaire réglable
- Facile à accrocher au mur
- Idéal pour des livres et des CD
- Livré avec support mural
- Facile à assembler

Ginevra cod. 3002

REGAL

- Struktur aus massivem Buchenholz
- Stangen aus gebürstetem Metall
- Einstellbares Modulregal
- Einfach an die Wand zu hängen
- Ideal für Bücher und CDs
- Komplet mit Wandhalterung
- Einfach zu montieren

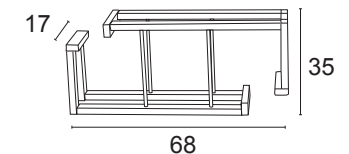

Posizionabile:
• verticale
• orizzontale
• obliqua

Positioned
• vertical
• horizontal
• oblique

• Kann vertikal
• horizontal
• schräg
positioniert werden

Positionnement
• vertical
• horizontal
• oblique



CARRELLO SERVIZIO

- Struttura in faggio massiccio
- Ripiani in laminato antigraffio
- Sistema di chiusura brevettato
- Ruote piroettanti antitraccia

Gimmy

cod. 570

SERVICE TROLLEY

- Massive beech structure
- Non-scratch laminated plane
- Patented closing system
- Anti-trace revolving wheels.

SERVIERWAGEN

- Massivbuchenholz Struktur
- Fläche in kratzfestem Laminat
- Patentierks-SchlieBsystem
- Drehräder in Zeichensicher-Gummi

CHARIOT DE SERVICE

- Structure en hêtre massif
- Plateau verre synthétique fumé
- système de fermeture breveté
- Roulettes pivotantes antitraces

naturale - natural
natürlich - naturelle

ciliegio - cherry wood
Kirschholz - merisier



wenghé - wenghé - wengé

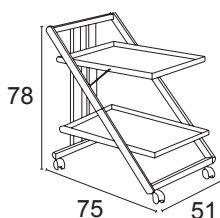

Gimmy

con vetro sintetico
cod. 570vs

With synthetic glass
Mit synthetischem glas
Avec verre synthétique



chiuso cm 11
closed cm 11
zusammengeklappt cm 11
clos cm 11

CARRELLO SERVIZIO

- Struttura in faggio massiccio
- Ripiani in laminato antigraffio
- Sistema di chiusura brevettato
- Ruote piroettanti antitraccia

Simpaty

cod. 575



laccato bianco - white laquered
weiß lackiert - laque blanc



sbiancato - whitened
gebleicht - blanchie

SERVICE TROLLEY

- Massive beech structure
- Non-scratch laminated plane
- Patented closing system
- Anti-trace revolving wheels.

SERVIERWAGEN

- Massivbuchenholz Struktur
- Fläche in kratzfestem Laminat
- Patentierks-SchlieBsystem
- Drehräder in Zeichensicher-Gummi

CHARIOT DE SERVICE

- Structure en hêtre massif
- Plateau stratifié antirayures
- système de fermeture breveté
- Roulettes pivotantes antitraces



chiuso cm 10
closed cm 10
geschlossen cm 10
clos cm 10

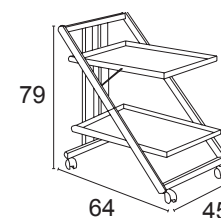

ciliegio - cherry wood
Kirschholz - merisier



CARRELLO ARREDO

- struttura in faggio massiccio
- 3 ripiani in vetro sintetico fumè
- ruote piroettanti antitraccia
- disponibile nelle versioni ciliegio, laccato bianco e laccato nero

SERVICE TROLLEY

- massive beech structure
- 3 wide shelves made of synthetic smoke-grey glass
- anti-trace revolving wheels
- available in versions cherry wood, white laquered and black laquered

SERVIERWAGEN

- Struktur in Massivbuchenholz
- 3 Glasböden synthetischen rauchigen
- Dreh-und Sperräder gummi no-marking
- in Kirsche, weiß lackiert und Schwarz lackiert

CHARIOT

- structure en hêtre massif
- 3 plateau en verre synthétique fumé
- roulettes pivotantes antitracesdisponible en finition merisier, laque blanc, laque noir

Gregory

cod. 3310



laccato bianco - white laquered
weiß lackiert - laque blanc



ciliegio - cherry wood
Kirschholz - merisier

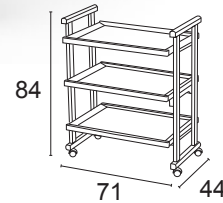

Anthony

cod. 2210

CARRELLO ARREDO

- struttura in faggio massiccio
- 2 ripiani in vetro sintetico fumè
- ruote piroettanti antitraccia
- disponibile nelle versioni ciliegio, laccato bianco e laccato nero

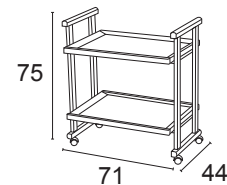

laccato bianco - white laquered
weiß lackiert - laque blanc

SERVICE TROLLEY

- massive beech structure
- 2 wide shelves made of synthetic smoke-grey glass
- anti-trace revolving wheels
- available in versions cherry wood, white laquered and black laquered

SERVIERWAGEN

- Struktur in Massivbuchenholz
- 2 Glasböden synthetischen rauchigen
- Dreh-und Sperräder gummi no-marking
- in Kirsche, weiß lackiert und Schwarz lackiert

CHARIOT

- structure en hêtre massif
- 2 plateau en verre synthétique fumé
- roulettes pivotantes antitracesdisponible en finition merisier, laque blanc, laque noir



ciliegio - cherry wood - Kirschholz - merisier

PORTACOMPUTER

- Struttura in faggio massiccio
- Ripiani in truciolare nobilitato
- Ampio cassetto
- Sistema aprifacile delle ali laterali
- Ruote piroettanti e autobloccanti

Lionello

cod. 552

COMPUTER CARRIER

- Massive beech structure
- Noble chipboard shelves
- Wide drawer
- Easy-open system of the side wings
- Revolving end clamping wheels

COMPUTERWAGEN

- Massivbuchenholz Struktur
- Ebene in veredelte Kernholz Spanplatte
- Grosse Schublade
- „einfach zu Öffnen“ System der seitlichen Ebene
- Dre-und Sperräder

CONSOLE INFORMATIQUE

- structure en hêtre massif
- plateau en panneaux de particules
- 2 tablettes latérales à ouverture facile + 1 tiroir
- roulettes pivotantes avec 4 freins

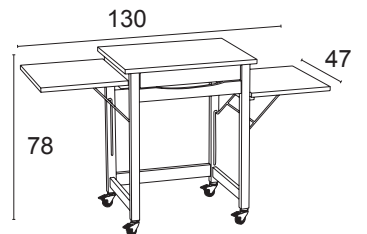

TAVOLO

- Struttura in faggio massiccio
- Piani in truciolare nobilitato massellati
- Facilmente richiudibile
- Piano girevole
- Piedini regolabili
- Ruote piroettanti e bloccanti
- Può contenere n° 6 sedie Diana

Indaco cod. 652

TABLE

- Massive beech structure
- Noble beaten-out chipboard plane
- Easy to close
- Revolving plane
- Revolving end clamping wheels
- Adjustable feet
- May contain n° 6 Diana chairs

TISCH

- Massivbuchenholz Struktur
- Ebene in veredelte Kernholz Spanplatte
- Einfach zu schließen
- Drehfläche
- Einstellbare Füßchen
- Dreh- und Sperrräder
- Kann 6 Stühle Diana enthalten

TABLE RECTANGULAIRE

- Structure en hêtre massif
- Plateau en panneaux de particules
- Ouverture et fermeture facile du plateau
- Pieds réglables
- 4 roulettes pivotantes avec 4 freins
- Peut contenir 6 chaises DIANA en position fermée

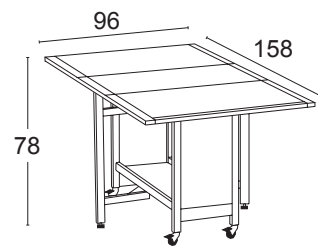
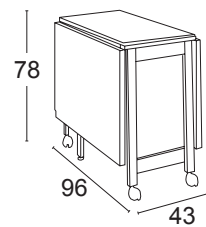

TAVOLO VALIGETTA

- Struttura in faggio massiccio
- Ripiani in multistrato
- Facilmente richiudibile
- Piedini in gomma alla base
- Disponibile in versione color sabbia

Joker cod. 665

TABLE CASE

- Massive wooden structure
- Shelf multi-layer
- Easy to close
- Rubber feet at the base
- Available in colour sand

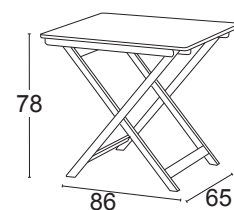

cm 12

KOFFERTISCH

- Struktur aus massivem Buchenholz
- Regale aus Sperrholz
- Leicht faltbar
- GummifüÙe an der Basis
- Erháltlich in Sandfarbe

TABLE VALISE

- Structure en hêtre massif
- Rayons en contreplaqué
- Facilement pliable
- Pieds en caoutchouc à la base
- Disponible en couleur sable



Immagine composta da Joker e 4 Jolly
composition pictures with Joker and 4 Jolly
Bild von Joker und 4 Jolly zusammen
Image composée de Joker et 4 Jolly



Immagine composta da Joker e 4 Diana
composition pictures with Joker and 4 Diana
Bild von Joker und 4 Diana zusammen
Image composée de Joker et 4 Diana



Immagine composta da Joker e 2 Diana
composition pictures with Joker and 2 Diana
Bild von Joker und 2 Diana zusammen
Image composée de Joker et 2 Diana

SGABELLO VALIGETTA

- Struttura in faggio massiccio
- Seduta in multistrato
- Facilmente richiudibile
- Piedini in gomma alla base
- Disponibile in versione color sabbia

Jolly cod. 667

STOOL CASE

- Massive wooden structure
- Sitting multy layer
- Easy to close
- Rubber feet at the base
- Available in colour sand

KOFFERHOCKER

- Struktur aus massivem Buchenholz
- Sitz aus Sperrholz
- Leicht faltbar
- GummifüÙe an der Basis
- Erháltlich in Sandfarbe

TABOURET VALISE

- Structure en hêtre massif
- Siège de contreplaqué
- Facilement pliable
- Pieds en caoutchouc à la base
- Disponible en couleur sable



cm 12

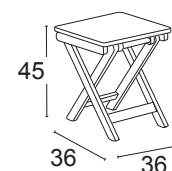

Immediato sistema apri/chiodi autobloccante
Immediate gaming open/close locking
Sofort-Gaming-open/close Sperr
Jeu immédiat ouvrir/fermer blocage



TAVOLO CONSOLLE CHIUDIBILE

- Struttura in faggio massiccio
- Piani in truciolare nobilitato massellati
- Facilmente richiudibile

Smile cod. 654

TABLE-CONSOLLE CLOSED

- Massive wooden structure
- Noble beaten-out chipboard plane
- Easy to close



SCHLISSBARER KONSOLLE-TISCH

- Massivbuchenholz Struktur
- Ebene in veredelte Kernholz Spanplatte
- Einfach zu schließen

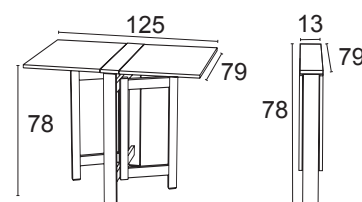

TABLE CONSOLLE PLIABLE

- Structure en hêtre massif
- plateau en panneaux de particules
- ouverture et fermeture facile

SEDIA CHIUDIBILE

- Struttura in faggio massiccio
- Seduta in listellare di faggio / multistrato
- Piedini antiscivolo

Diana cod. 660

CHAIR CLOSED

- Massive wooden structure
- Sitting beech wood lamellate / multy layer
- Non-slip feet at the base

KLAPPSTUHL

- Massivbuchenholz Struktur
- Sitzen in buche massiv / Sperrholz
- rutschfesten Füßchen

CHAISE PLIABLE

- Structure en hêtre massif
- Assise en panneau d'hêtre / contreplaqué
- Patins anti-dérapant

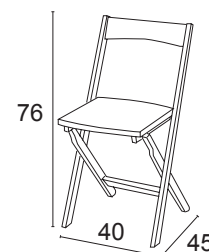

ciliegio - cherry wood
Kirschholz - merisier



Sabbia - Sand
Sand - sable



chiuso cm 6
closed cm 6
zusammengeklappt cm 6
clos cm 6



CARRELLO PORTASEDIE

- Può contenere fino a 6 sedie Diana

Zeus cod. 655

TRANSPORTER CHAIR

- Can hold 6 Diana chairs

STUHLWAGEN

- Kann 6 Stühle Diana enthalten

CHARIOT RANGE CHAISES

- Capacité 6 chaises pliables Diana

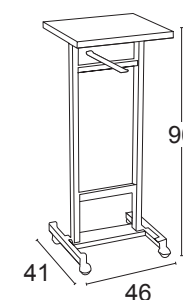

SGABELLO

- Struttura in faggio massiccio
- Ripiano in listellare di faggio
- Piedini antiscivolo alla base
- Ideale come appoggio per poltrone

Nello cod. 400

STOOL

- Structure in massive beech wood
- Beech wood lamellate shelf
- Non-slip feet at the base
- Ideal as a resting for armchairs

HOCKER

- Massivbuchenholz Struktur
- Ebene in Buchenholzleiste
- Anti-rutsch-füÙe an der unterseite
- deal als ausgangspunkt für stühle

TABOURET

- Structure en hêtre massif
- Surface en hêtre lamellaire
- Pieds anti-glissière à la base
- Idéal come appui pour fauteuils

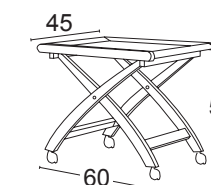
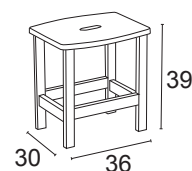

Billy cod. 551

TAVOLINO DA THÉ

- Struttura in faggio massiccio
- Vassoio asportabile in laminato
- Facilmente chiudibile
- Ruote piroettanti antitraccia

TEA TABLE

- Massive beech structure
- Removable laminated tray
- Easy to close
- Anti-trace revolving wheels

TEETISCH

- Massivbuchenholz Struktur
- Abnehmbares Laminat-Servierbrett
- Einfach zu schließen
- Drehräder in Zeichensicher-Gummi

PETITE TABLE À THÉ

- Structure en hêtre massif
- Plateau amovible stratifié
- Ouverture et fermeture facile
- Roulettes pivotantes antitraces



CARRELLO/VASSOIO REGOLABILE

- Struttura in faggio massiccio
- Ripiano in laminato antigraffio
- Sistema di regolazione a più altezze
- Ruote piroettanti antitraccia
- Vassoio inclinabile da entrambi i lati

Lapillo cod. 478

TRAY ADJUSTABLE TROLLEY

- Massive beech structure
- Non-scratch laminated tray
- Adjustable in more heights system
- Anti-trace revolving wheels.
- Tilting tray on both sides

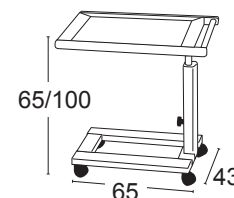

VESTELLBARER WAGEN/BRETT

- Massivbuchenholz Struktur
- Laminat Scratch
- verstellsystem mehr höhen
- Dreh-uns Sperräder grummi no-marking
- Neigbar tray von beiden seiten

CHARIOT PETIT DÉJEUNER À HAUTEUR RÉGLABLE

- Structure en hêtre massif
- Plateau stratifié résistant aux rayures
- Système de réglage différentes hauteurs
- Roulettes pivotantes antitraces
- Inclinaison plateau des deux côtés



PORTARIVISTE

- Struttura in faggio massiccio
- 4 ampi spazi
- Tasche in tessuto textilene
- Piedini antiscivolo

Matrix cod. 717

STAND MAGAZINE

- Massive beech structure
- 4 wide spaces for your magazine
- Textilene pockets
- Non-slip feet

ZEITSCHRIFTENSTÄNDER

- Buchenholz Struktur
- 4 große Zeitschriftenflächen
- Verkleidung in Textilene-Gewebe
- Basis Zeichensicher Drehräder

PORTE REVUES

- Structure en hêtre massif
- 4 poches de rangement
- Poche en tissu textilène
- Patins antidérapants à la base



CASSETTIERA

- Struttura in truciolare nobilitato
- Testate cassetti in faggio massiccio
- Ripiano in listellare di faggio
- Ruote piroettanti antitraccia

Afrodite

cod. 583

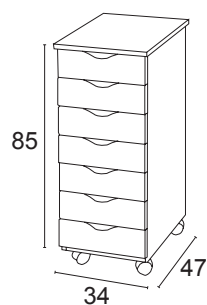

ciliegio - cherry wood
Kirschholz - merisier

BUREAU

- Noble chipboard structure
- Drawers heads in massive beech
- Beech lamellate shel
- Anti-trace revolving wheels

KOMMODE

- veredelte Kernholz Struktur
- Schubladen in Massivbuchenholz
- Ebene in veredelte Kernholz Spanplatte
- Drehräder in Zeichensicher-Gummi

CAISSON

- Structure en panneaux de particules
- Façades tiroirs en hêtre massif
- 7 tiroirs
- Plateau en panneaux d'hêtre
- Roulettes pivotante anti-trace



laccato bianco - white laquered
weiß lackiert - laqué blanc

PORTA SCARPE MODULARE

- Struttura in faggio massiccio
- Aste in metallo rivestite con gomma
- Sovrapponibile senza agganci
- Ogni modulo può contenere 6 paia di scarpe

Todys

 cod. 888

MODULAR SHOE CUPBOARD

- noble chipboard structure
- solid wood frames
- rubber feet at the base
- superimposable without any hook
- every single module can hold 6 pairs of shoes
- available in versions cherry wood and white laquered

BAUKASTENSCHUHSCHRANK

- Struktur in veredelte Spanholz
- Kernholzrahmen
- Gummi-Füßchen an der Grundlage
- übereinander legbar, ohne Kupplung
- jeder Modul kann 6 Paar Schuhe enthalten
- zur Verfügung in Kirschholz und weiß lack

ETAGERE A CHAUSSURES MODULABLE

- structure en panneaux de particules
- encadrement en bois massif
- patins en caoutchouc à la base
- empilable sans crochets
- chaque module peut contenir 6 paires de chaussures
- disponible en finition merisier ou laqué blanc

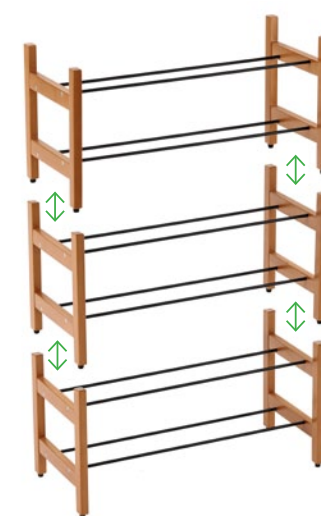
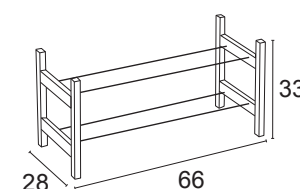
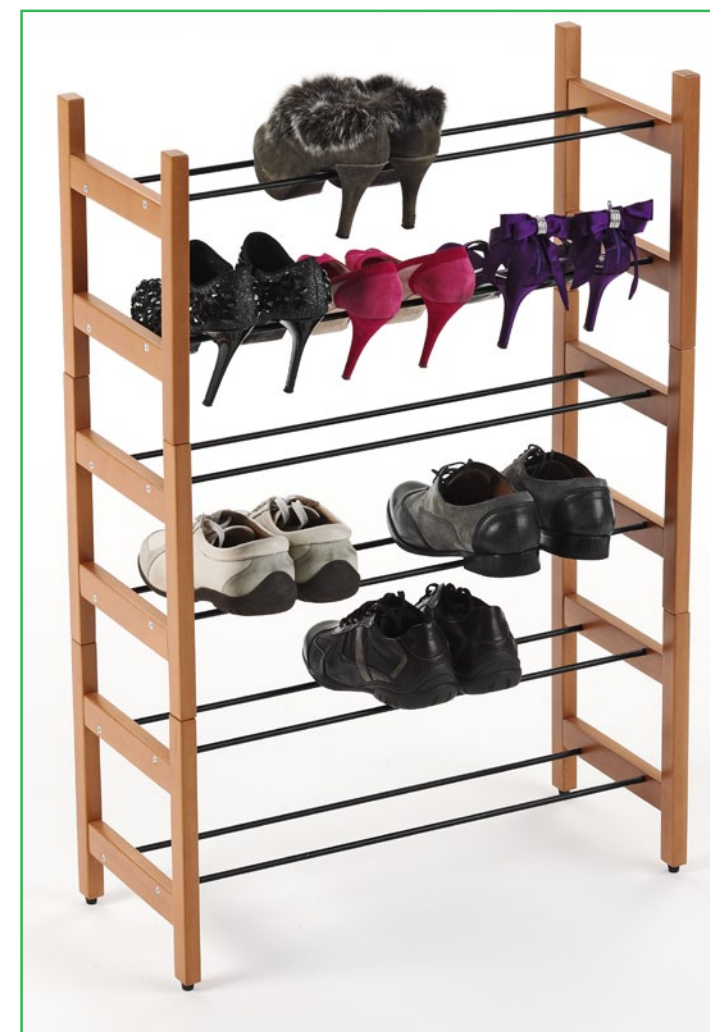



SCARPIERE

SHOE CUPBOARD
SCHUHSCHRANK
MEUBLE À CHAUSSURES

SCARPIERA

- Struttura truciolare nobilitato
- Cornici e ripiano superiore in legno massiccio
- Singola apertura delle antine
- Piedini in gomma alla base

SHOE CUPBOARD

- Noble chipboard structure
- Massive wooden frames and upper shelf
- Single opening of doors
- Rubber feet at the base

Gioia

cod. 880/3 (9 posti)

cod. 880/4 (12 posti)

cod. 880/5 (15 posti)

SCHUHSCHRANK

- veredelte Kernholz Struktur
- Rahmen und Oberfläche in Massivholz
- Einzelöffnung der Türen
- Basis Gummifußchen

MEUBLE À CHAUSSURES

- structure en panneaux de particules
- Encadrement des casiers et plateau supérieur en bois massif
- Ouverture individuelle des casiers
- patins en caoutchouc à la base du meuble





Variante con optional specchio da applicare
 Version with optional mirror to be applied
 Version mit Optional Spiegel zu anbringen
 Version avec miroir en option a appliquer

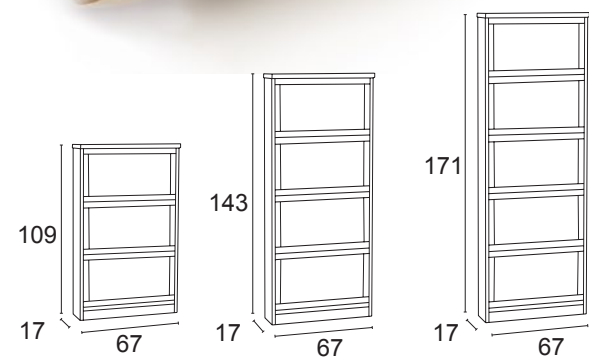

ripiano e cornici in legno massiccio
 massive wooden frames and upper shelf
 Massivholz Ebene und Rahmen
 Rayon et cadres en bois massif



Singola apertura delle antine
 Single opening of doors
 Einzelöffnung der Türe
 Ouverture de porte simple



cod. 880/5



cod. 880/4



cod. 880/3

ciliegio
 cherry wood
 Kirschholz
 merisier



cod. 880/3



cod. 880/4



cod. 880/5

laccato bianco
 white lacquered
 weisslackiert
 laqué blanc



cod. 880/5



cod. 880/4



cod. 880/3



MODULAR SHOE CUPBOARD

- noble chipboard structure
- solid wood frames
- rubber feet at the base
- superimposable without any hook
- every single module can hold 6 pairs of shoes
- available in versions cherry wood and white laquered

BAUKASTENSCHUHSCHRANK

- Struktur in veredelte Spanholz
- Kernholzrahmen
- Gummi-Füßchen an der Grundlage
- übereinander legbar, ohne Kupplung
- jeder Modul kann 6 Paar Schuhe enthalten
- zur Verfügung in Kirschholz und weiß lack

ETAGERE A CHAUSSURES MODULABLE

- structure en panneaux de particules
- encadrement en bois massif
- patins en caoutchouc à la base
- empilable sans crochets
- chaque module peut contenir 6 paires de chaussures
- disponible en finition merisier ou laqué blanc



laccato bianco
white lacquered
weisslackiert
laqué blanc



Variante con optional specchio da applicare
Version with optional mirror to be applied
Version mit Optional Spiegel zu anbringen
Version avec miroir en option a appliquer

SCARPIERA MODULARE

- Struttura in truciolare nobilitato
- Cornici in legno massiccio
- Piedini in gomma alla base
- Sovrapponibile senza agganci
- Ogni modulo può contenere 6 paia di scarpe
- Disponibile in ciliegio e laccato bianco e noce

Scarpierissima

cod. 886



ciliegio
cherry wood
Kirschholz
merisier



noce
walnut
Nussbaumholz
noix

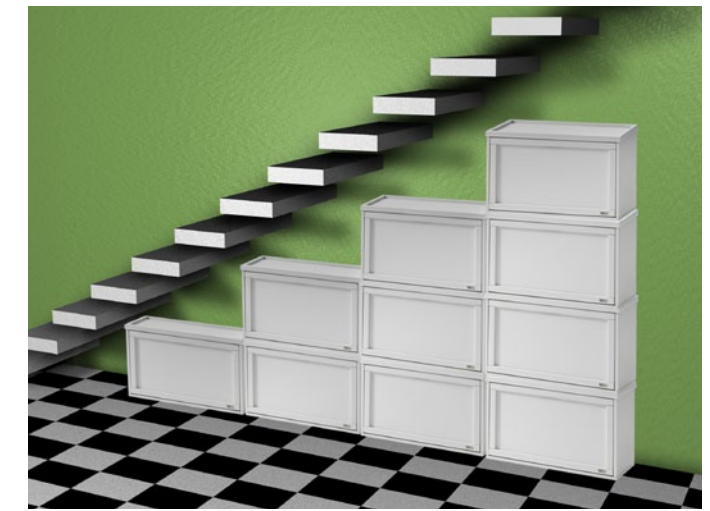
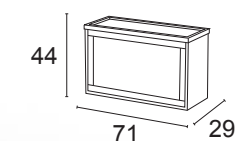

Ideale per recuperare spazi inutilizzati
Ideal to recover unused spaces
Ideal zur Rückgewinnung der unbenutzten Räume
Idéal pour récupérer espaces inutilisés





SCALE

LADDER
TREPPEN
ÉCHELLE

LA SEDIA SCALETTA

- Innovativa e robusta
- Gradini in legno antiscivolo
- Sistema di sicurezza con bloccaggi
- Un semplice movimento trasforma la sedia in scala
- Collaudati piedini antiscivolo alla base
- Chiusa sta in piedi da sola

THE LADDER CHAIR

- Innovative and sturdy
- Nonslip wooden steps
- Safety system with clamps
- A simple movement changes the chair into ladder
- Tested non-slip feet at the base
- When closed, it stands alone

LA CHAISE ESCABEAU

- innovante et robuste
- 4 marches en bois antidérapantes
- système de sécurité avec blocage
- Un simple mouvement transforme la chaise en escabeau
- Caoutchouc antidérapant a la base
- Tient debout toute seule en position fermée

TREPPENSTUHL

- Innovation und robust
- Rutschsichec Holztreppenstufen
- Sicherheitssystem mit Sperren
- Mit einfacher Bewegung wird der Stuhl eine Treppe
- Basis Rutschfesten Fußschen
- Wenn geschlossen, steht sie von selbst

Eletta

cod. 175

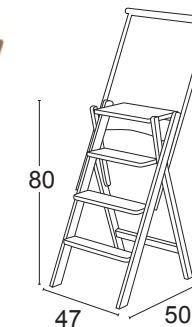
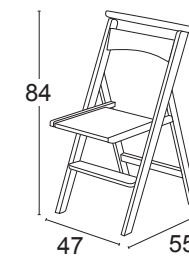

SCALE

- Completamente in faggio massiccio
- Semplicissimo sistema di chiusura
- Piedini in gomma antiscivolo alla base
- Gradini antiscivolo
- Ampia pedana per uno stabile appoggio

Kimora cod. 180

LADDERS

- Complete massive beech
- Very simple opening system
- Rubber feet at the base
- Non-slip steps
- Wide footboard for a stable base

TREPPEN

- Vollständig Massivbuchenholz
- Sehr einfaches Schließ-System
- Basis Gummifußchen
- Grosses Trittbrett für Treppenstufen
- Grosses Trittbrett für einer stabile Stützung

ESCALIER

- Complètement en hêtre massif
- Système de fermeture très simple
- Pieds anti-glissière à la base
- Marches anti-glissière
- Ample estrade pour un appui stable.



MISURE SCALE / LADDER SIZE	180/4	180/3	180/2
Chiusa / Close	h 148 - L 48 - p 9	h 123 - L 48 - p 9	h 98 - L 48 - p 9
Aperta / Open	h 141 - L 48 - p 77	h 116 - L 48 - p 66	h 94 - L 48 - p 51
Altezza pedana / platform height	80	60	40

SGABELLO SCALETTA

Osimo cod. 70

LITTLE LADDER

TREPPCHEN

TABOURET ESCALIER

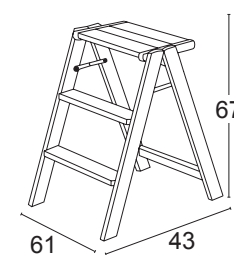



SCALE

- Struttura in faggio massiccio
- Robusta e molto sicura
- Dotata di pedana per uno stabile appoggio
- Ampio portaattrezzi superiore
- Sistema di apertura brevettato
- Chiusa sta in piedi da sola
- Gradini antiscivolo
- Facilmente spostabile grazie alle ruote che lavorano solo nella posizione chiusa

Tuscania

LADDERS

- Massive beech structure
- Sturdy and very secure
- Equipped with footboard for a stable resting
- With upper tool box
- Patented opening system
- When closed it stands alone
- Nonslip wooden steps
- Easy to move thanks to wheels acting only in closed position

TREPPEN

- Massivbuchenholz Struktur
- Stark und sehr sicher
- Ausgestattet mit Trittbrett für einer stabile Stützung
- Großer Oben-Geräteträger
- Patent-Öffnungssystem
- Wenn geschlossen, steht sie von selbst
- Rutschfesten Treppenstufe
- Einfach zu verstellen dank die Räder die nur wenn sie geschlossen ist, wirken



ECHELLE DE BIBLIOTHÈQUE

- Structure en hêtre massif
- Résistante et sécurisée
- Porte accessoires au niveau supérieur
- Système d'ouverture breveté
- Marches anti-dérapantes
- Déplacement facilité grâce aux 4 roulettes qui fonctionnent uniquement en position fermée





guida di scorrimento in nylon
 nylon non-slip guideway
 Nylon Führungsschienen
 Coureur de nylon



pedino antiscivolo
 non-slip foot
 Rutschfesten Fußchen
 Pieds anti-glissière



ruota antitraccia
 anti-trace wheel
 Zeichensicher-Rad
 Roulettes antitraces



Tuscania

MISURE SCALE / LADDER SIZE	170/3	170/4	170/5	170/6
Chiusa / Close	h 99 - L 49,5 - p 12	h 118 - L 49,5 - p 12	h 138 - L 49,5 - p 12	h 164 - L 49,5 - p 12
Aperta / Open	h 145 - L 49,5 - p 65	h 162 - L 49,5 - p 65	h 182 - L 49,5 - p 69	h 206 - L 49,5 - p 110
Altezza pedana / platform height	72	89	109	132



CAMERA

BEDROOM - SCHLAFZIMMER - CHAMBRE



naturale - natural
natürlich - naturelle

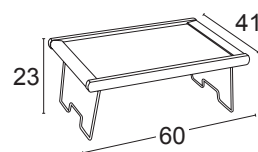

ciliegio - cherry wood
Kirschholz - merisier

VASSOIO COLAZIONE

- Cornice in faggio massiccio
- Ripiano in laminato
- Telaio d'appoggio in metallo
- Facilmente richiudibile

Melfo cod. 470

BRAKEFAST TRAY

- Frame in massive beech wood
- Laminated shelf
- Metallic bearing legs
- Easy-to-close

FRÜHSTÜCKBRETT

- Rahmen in Massivbuchenholz
- Laminatenebene
- Metall-Stützfläche
- Einfach zu schließen

PLATEAU PETIT DÉJEUNER

- Encadrement en hêtre massif
- plateau en mélaminé
- support d'appui en métal
- Fermeture facile

APPENDI PANTALONI

- Struttura in faggio massiccio
- Pinze appendigonna
- Ampia vaschetta portaoggetti
- Pratico portacravatte / portacinture
- Piedini in gomma alla base
- Innovativo sistema appendipantaloni



Joseph

cod. 2005

CLOTHES CARRIER

- Massive beech structure
- Elegant room clothes carrier
- Object case
- Non-slip feet at the base
- Innovative hanging pants
- Skirt nippers

KLEIDERSTÄNDER

- Massivbuchenholz Struktur
- Eleganter Kammerkleiderständer
- Ablagefach
- Basis Zeichensicher Drehräder
- Innovative hängende Hosen
- Rockträger

VALET DE NUIT DOUBLE

- Structure en hêtre massif
- cintre pour veste, repose pantalon
- porte cravates, vide poches
- pieds antidérapants
- Innovantes pantalons suspendus
- Pince jupes

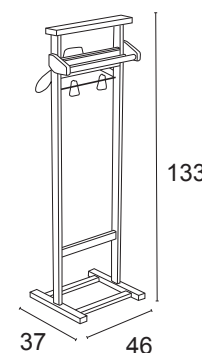



naturale - natural
natürlich - naturelle



wenghè - wenghè - wengé



ciliegio - cherry wood
Kirschholz - merisier



naturale - natural
natürlich - naturelle



wenghè - wenghè - wengé



ciliegio - cherry wood
Kirschholz - merisier



laccato bianco
white lacquered
weisslackiert
laqué blanc

INDOSSATORE DOPPIO

- Struttura in faggio massiccio
- Elegante portabiti da camera
- Doppia spalla appendigiacca
- Pinze appendigonna
- Vaschetta portaoggetti
- Ruote piroettanti alla base

Mixer

cod. 2003

DOUBLE CLOTHES CARRIER

- Massive beech structure
- Elegant room clothes carrier
- Double shoulder for jacket carrier
- Skirt nippers
- Object case
- Revolving wheels at the base

VALET DE NUIT DOUBLE

- Structure en hêtre massif
- Pince jupes, porte cravattes, vide poches
- Double cintres pour veste
- Roulettes pivotantes

DOPPEL KLEIDERSTÄNDER

- Massivbuchenholz Struktur
- Eleganter Kammerkleiderständer
- Doppel Jackenträger
- Rockträger
- Ablagefach
- Basis Drehräder

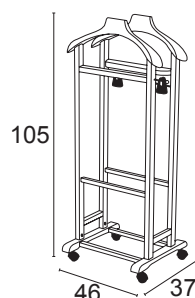

laccato bianco
white lacquered
weisslackiert
laqué blanc

INDOSSATORE

- Struttura in faggio massiccio
- Elegante portabiti da camera
- Vaschetta portaoggetti
- Ruote piroettanti alla base

Mirano

cod. 2002

VALET DE NUIT

- Structure en hêtre massif
- cintre pour veste, repose pantalon
- porte cravates, vide poches
- roulettes pivotantes

KLEIDERSTÄNDER

- Massivbuchenholz Struktur
- Eleganter Kammerkleiderständer
- Ablagefach
- Basis Drehräder

CLOTHES CARRIER

- Massive beech structure
- Elegant room clothes carrier
- Object case
- Revolving wheels at the base

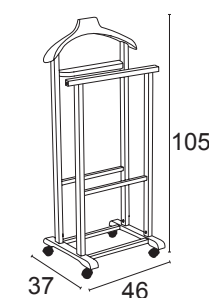

INDOSSATORE

- Struttura in faggio massiccio
- Base in truciolare nobilitato
- Ruote antitraccia alla base
- Pratica vaschetta vuotatasche

Antimo

 cod. 18

VALET

- Structure in massive beech wood
- Noble chipboard base
- Revolving wheels at the base
- Practical pockets emptier

KLEIDERSTÄNDER

- Massivbuchenholz Struktur
- veredelte Kernholzbasis
- Basis Zeichensicher Drehräder
- Ablagefach

VALET DE NUIT

- Structure en hêtre massif
- Base en panneaux de particules
- roulettes antitraces
- Vide poches

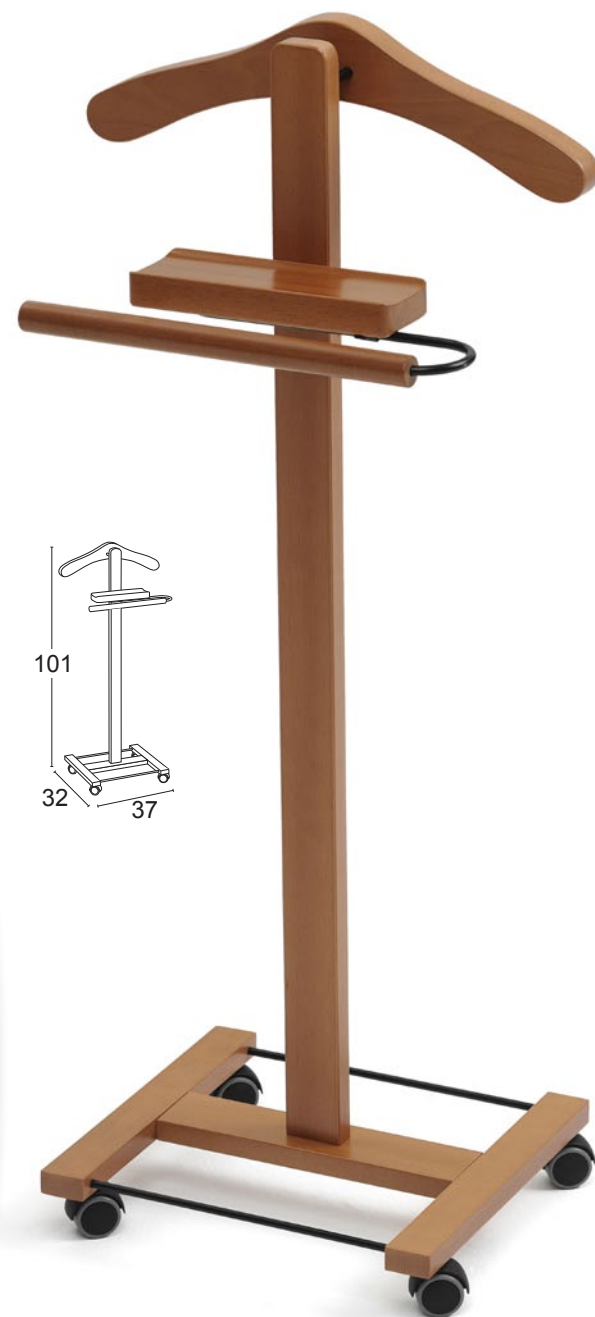

INDOSSATORE

- Struttura in faggio massiccio
- Ruote antitraccia alla base
- Pratica vaschetta vuotatasche

Junior

 cod. 105

VALET

- Structure in massive beech wood
- Revolving wheels at the base
- Practical pockets emptier

KLEIDERSTÄNDER

- Massivbuchenholz Struktur
- Basis Zeichensicher Drehräder
- Ablagefach

VALET DE NUIT

- Structure en hêtre massif
- roulettes antitraces
- Vide poches

INDOSSATORE

- Classico servo muto da camera
- Completamente in faggio massiccio
- Ruote antitraccia alla base

Atri

 cod. 102

VALET

- Classical sleeping room valet
- Completely made of massive beech wood
- Anti-trace wheels at the base

KLEIDERSTÄNDER

- Klassischer Kammerständer
- Vollständig Massivbuchenholz
- Basis Zeichensicher Drehräder

VALET DE NUIT

- Entièrement en hêtre massif
- cintre pour veste
- repose pantalon antiglissant
- roulettes antitraces

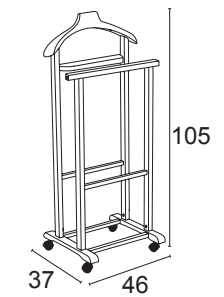

ciliegio - cherry wood
Kirschholz - merisier

INDOSSATORE CHIUDIBILE

- Struttura in faggio massiccio
- Facilmente richiudibile
- Ruote antitraccia
- Appoggio in tessuto textilene

Nelson

cod. 119



VALET CLOSED

- Structure in massive beech wood
- Easy closed
- Anti-trace wheels
- Textilene support on the base

SCHLISSBARER KLEIDERSTÄNDER

- Massivbuchenholz Struktur
- Zeichensicher-Gummi Räder
- schließbar
- Stützung in Textilene-Gewebe

VALET DE NUIT PLIABLE

- Structure en hêtre massif
- Fermeture facile
- Roulettes antitraces
- Support en textilène



chiuso - closed - geschlossen - clos
cm 9

INDOSSATORE SEDIA

- Struttura in faggio massiccio
- Seduta in listellare di faggio
- Ampia vaschetta portaoggetti
- Chiuso sta in piedi da solo

Duka cod. 2007

CHAIR VALET

- Structure in massive beech wood
- Sit-on in beech wood lamellate
- Wide object case
- When closed, it stands alone



STUHL-KLEIDERSTÄNDER

- Massivbuchenholz Struktur
- Sitzlage in Buchenholzleiste
- Grosse Ablagefach
- Wenn geschlossen, steht er von selbst

VALET DE NUIT CHAISE

- Structure en hêtre massif
- assise en hêtre lamellé
- 2 vides poches
- Tient debout tout seul en position fermée

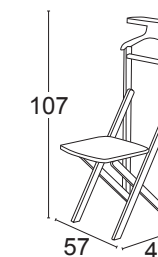

STIRAPANTALONI

- Struttura in faggio massiccio
- Pannelli in truciolare nobilitato
- Ruote piroettanti alla base

Lorenz

 cod. 2300

TROUSERS IRONING

- Frame in massive beech wood
- Noble chipboard panels
- Revolving wheels at the base

HOSENPRESSE

- Massivbuchenholz Struktur
- veredelte Kernholz Paneele
- Basis Drehräder

BASIS DREHRÄDER

- Encadrement en hêtre massif
- Plateau petit déjeuner
- Roulettes pivotantes

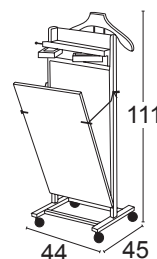

naturale - natural
natürlich - naturelle

ciliegio - cherry wood
Kirschholz - merisier



ciliegio - cherry wood
Kirschholz - merisier

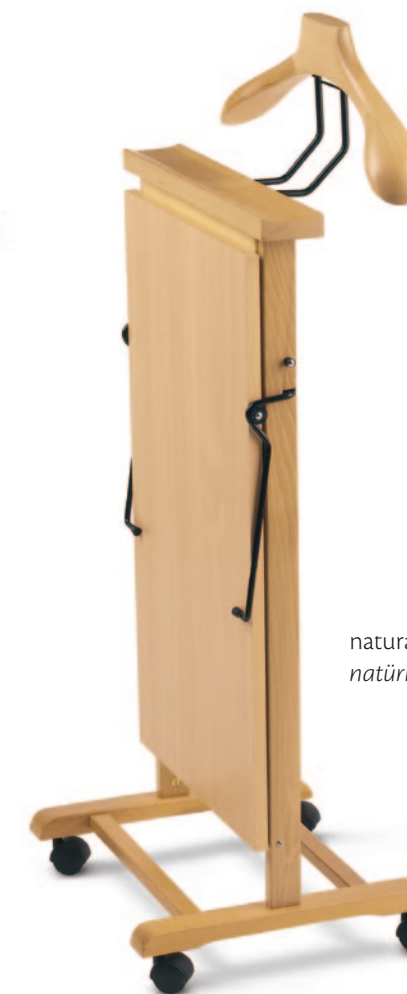

naturale - natural
natürlich - naturelle

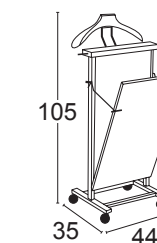

STIRAPANTALONI

Wigi

 cod. 100

TROUSERS IRONING

HOSENPRESSE

VALET DE NUIT REPASSE PANTALON

PORTACRAVATTE

- Struttura in faggio massiccio
- 23 ganci orientabili
- Applicabile all'anta dell'armadio

Red

 cod. 639

TIE RACK

- Structure in massive beech wood
- 23 orientable hooks
- Can be fit to the wardrobe door

KRAVATTENSTÄNDER

- Massivbuchenholz Struktur
- 23 verstellbare Haken
- Kann an Schranktür angebracht werden

PORTE - CRAVATES

- structure en hêtre massif
- 23 crochets orientables
- Peut être adapté à la porte de la penderie



Lavoriamo il legno da sempre e, da sempre, sappiamo esaltarne tutte le qualità e la bellezza. Il nostro Prodotto nasce da mani artigiane che, piegando questo nobile materiale e alla loro sapiente volontà, sanno assecondare le esigenze del design più attuale.



Seit jeher verarbeiten wird das Holz und, seit jeher, wissen wir alle Qualitäten und Schönheiten hervorheben. Unseres Produkt wird von Handwerkshänden erschaffen, die diesen Edelmateriale an geschickter Wille beugen und die die Erfordernisse des besten Designs begünstigen können.

We have been processing wood since ever and since ever we know how to enhance all its qualities and its beauty. Our Product is made by skilful artisans who, by bending this noble material to their expert will, perfectly know how to comply with the exigencies of any up-to-date design.

Nous travaillons le bois dès toujours et, dès toujours, nous sommes à même d'en exalter les vertus et la beauté. Notre produit naît de mains artisanes qui, tout en pliant ce matériel noble grâce à leur savant volonté, peuvent exaucer les exigences les plus actuelles du design.



Armonie Casa collection

Created by

Studio Tecnico Arredamenti Italia Group

Art direction

Diego Fogliata

Artwork

I.L.B. srl Brescia

Photo

Studio Fotografico Piero Fasanotto

Models

Muresan Nicole
Sancez Maria
Busazzi Christine
Rossi Jennifer

Print

Grafica Sette srl

Factory address

ARREDAMENTI ITALIA GROUP SRL

Via Combattenti e Reduci n° 6

25070 Bione (BS)

Tel. 0365 896668 - Fax 0365 896729

info@arredamentiitalia.net



**ARREDAMENTI
ITALIA**
IL CUORE DEL LEGNO



L'Arredamenti Italia Group s.r.l. garantisce che gli articoli presentati in questo catalogo sono prodotti nei propri stabilimenti di Bione (Bs).

Le varie tipologie di legni utilizzati per i nostri prodotti provengono da zone coltivate con continuo rimboscamento degli alberi tagliati per mantenere naturale l'ambiente.

The wood used for our products derives from cultivated areas, with continuous reforestation of the trees that have been cut in order to maintain the natural environment.

Die Hölze welches fuer unsere Produkte verwendet wird, gezeuchtete Gebiete, mit einer staendigen Aufforstung der geschnittenen Baeume, um das naturelle Milieu zu bewahren.

Le bois utilisé pour produits vient de zones cultivées avec un reboisement continuel des arbres coupés pur maintenir le milieu naturel.

CATALOGO N° 33

gennaio 2014

Nell'ottica di un continuo miglioramento qualitativo Arredamenti Italia si riserva di modificare i prodotti del catalogo, senza preavviso.

Arredamenti Italia reserves the rights to modify the products of the catalogue, also without notice.

Arredamenti Italia behaelt sich das Recht vor, die Produkte des Katalogs zu aendem, selbst ohne vorherige Benachrichtigung.

Arredamenti Italia se réserve de modifier les produits du catalogue même sans préavis.

www.ar-it.it
www.arredamentiitalia.net



www.ar-it.it
www.arredamentiitalia.net



Arredamenti Italia

CATALOGO N° 33 - 2014

RIVENDITORE AUTORIZZATO